

**PLAN OF BELL CAPTAIN COUNTER**  
SCALE: 1/4" = 1'-0"

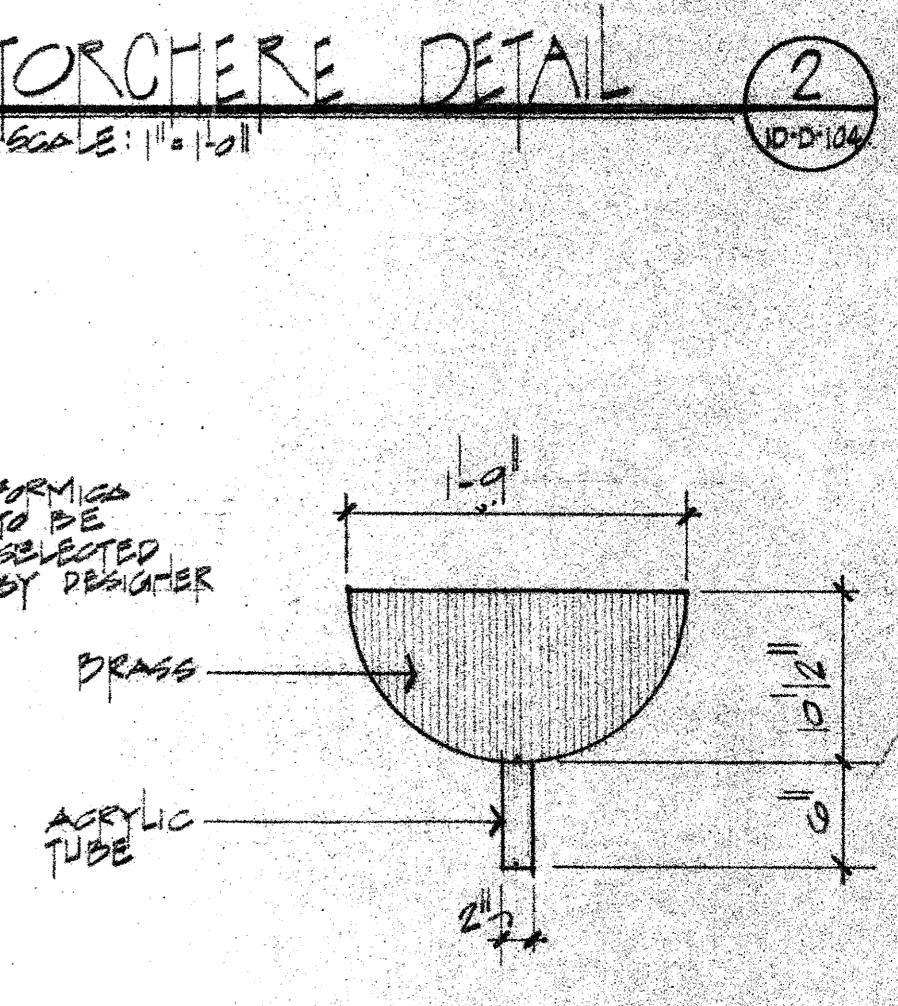

**PLAN OF FRONT DECK**  
SCALE: 1/4" = 1'-0"

**SECTION D**  
SCALE: 1/4" = 1'-0"

**SECTION E**  
SCALE: 1/4" = 1'-0"

**WALLSCOTCH DETAIL**  
SCALE: 1/4" = 1'-0"

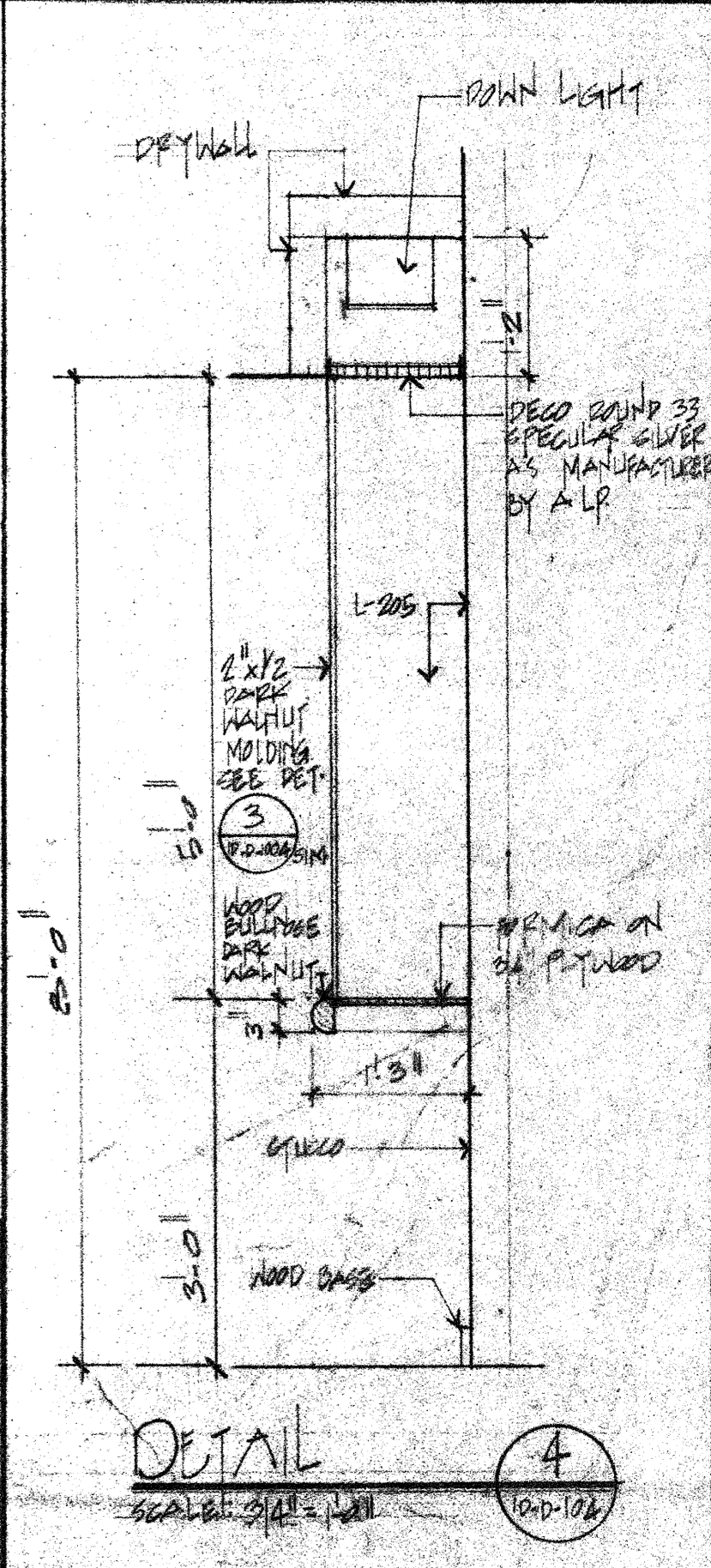
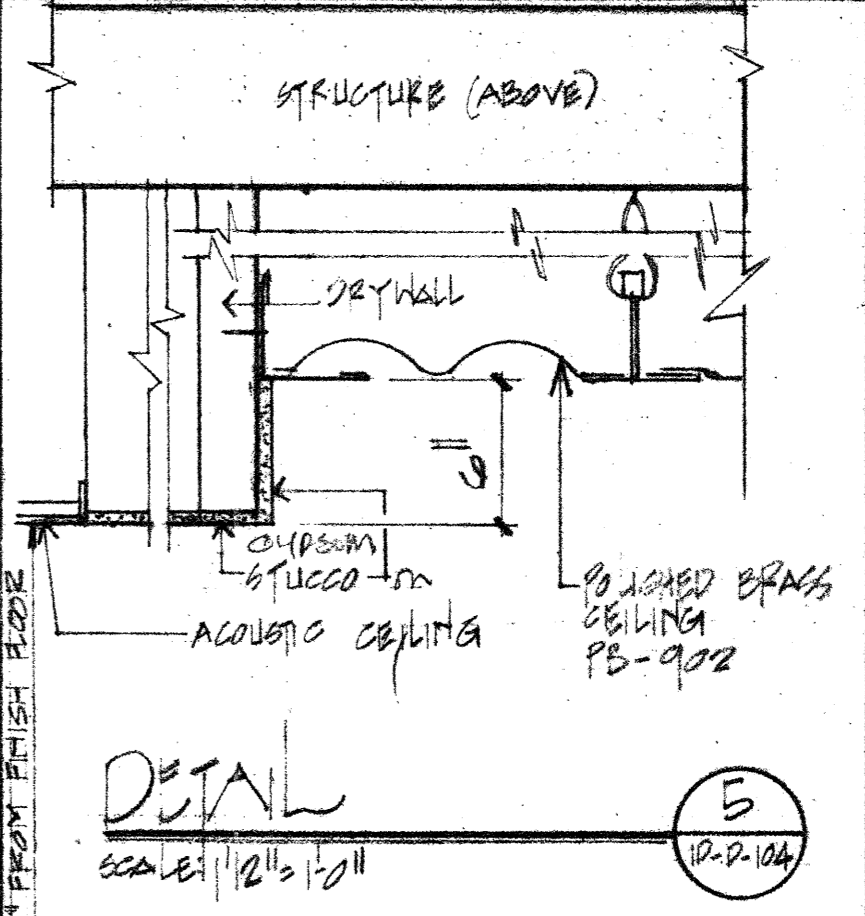
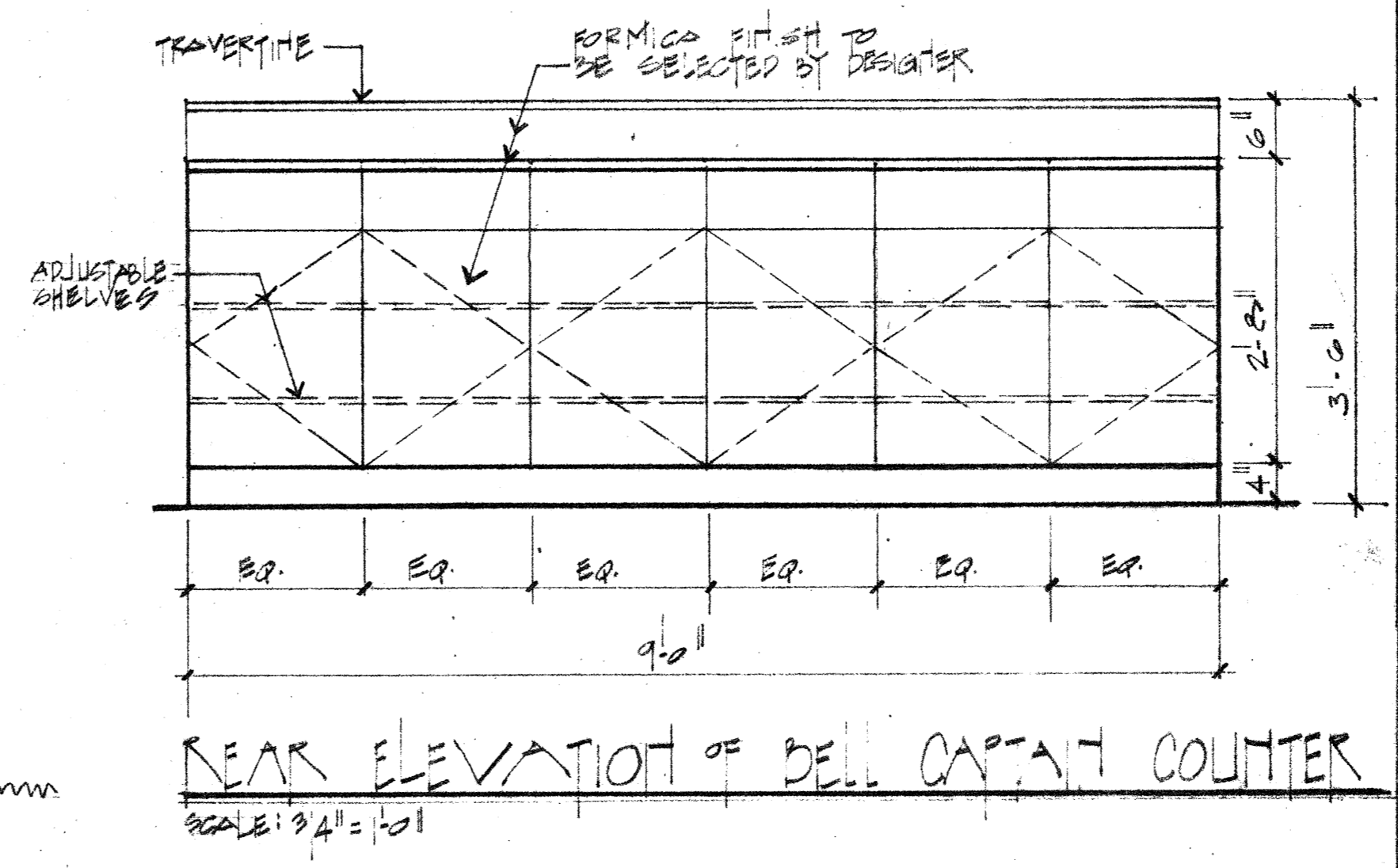
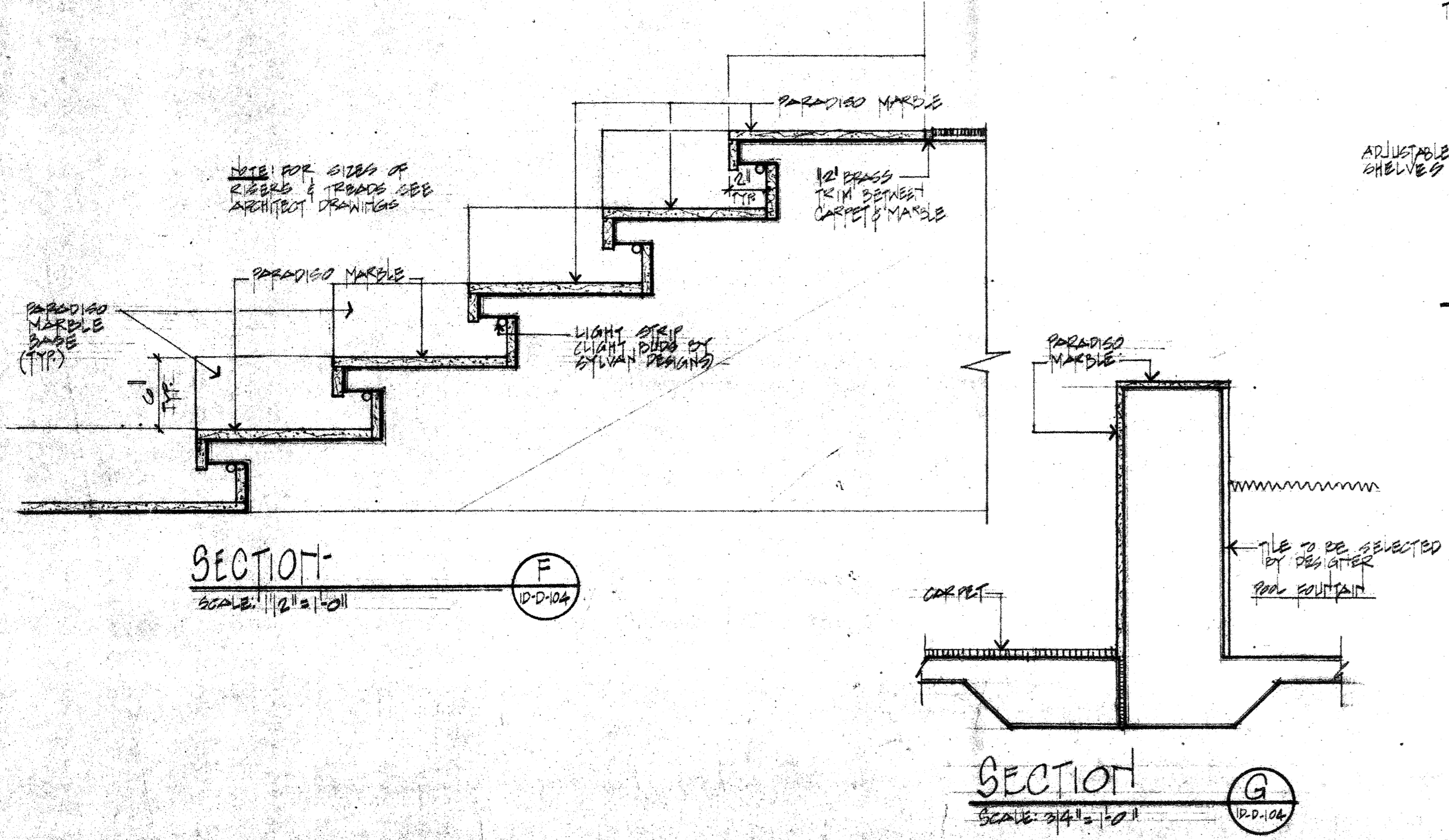

project no. 10-D-104  
revisions (1) 7-7-83 (2) 8-12-83

**MORRIS-POWELL ASSOCIATES, INC.**  
interior designers consultants  
4500 biscayne boulevard suite 200  
miami, florida 33137  
(305) 576-6551

project **CAPITOL PLAZA HOTEL**  
FRANK PAST KETLOUKY  
LOBBY & PLATO BAR DETAILS

**10-D-104**  
sheet  
scale AS SHOWN  
date 8-11-83

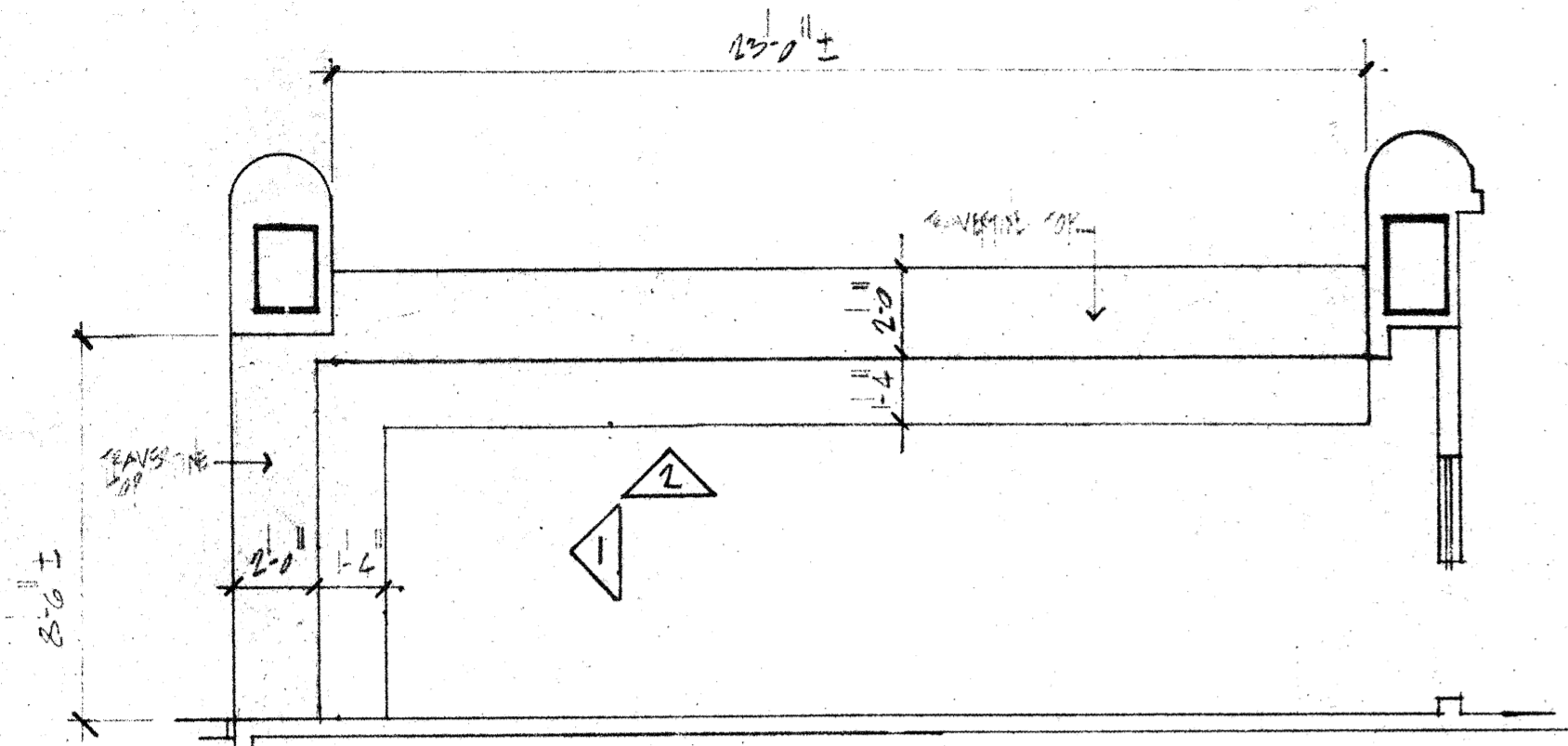

PLAN OF DESK  
SCALE: 1/4" = 1'-0"

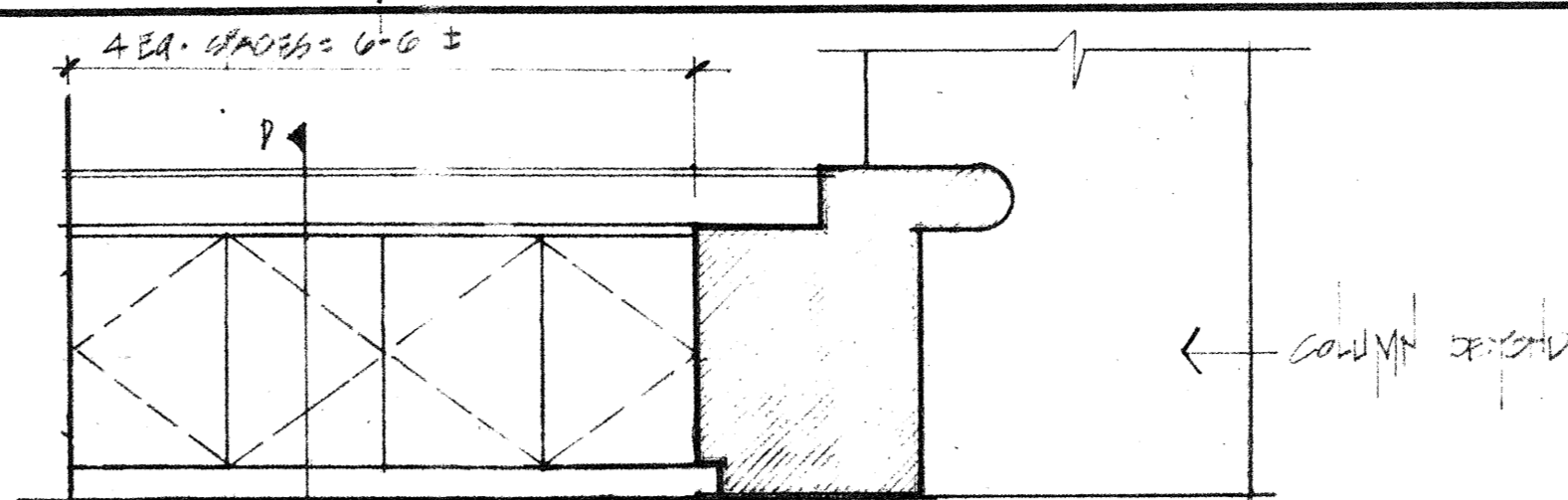

ELEVATION  
SCALE: 1/2" = 1'-0"

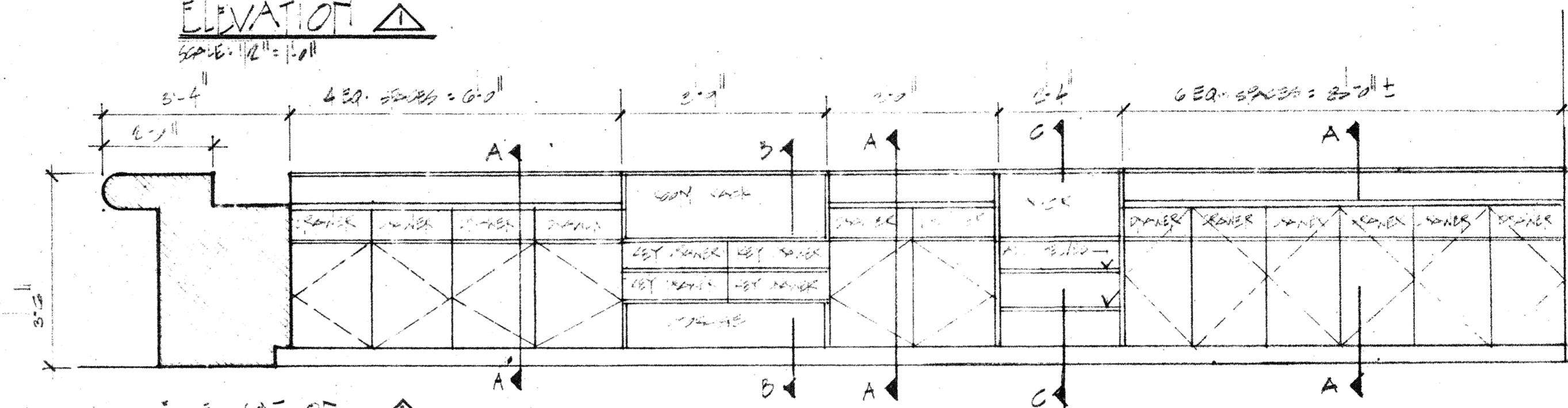

SECTION  
SCALE: 1/2" = 1'-0"

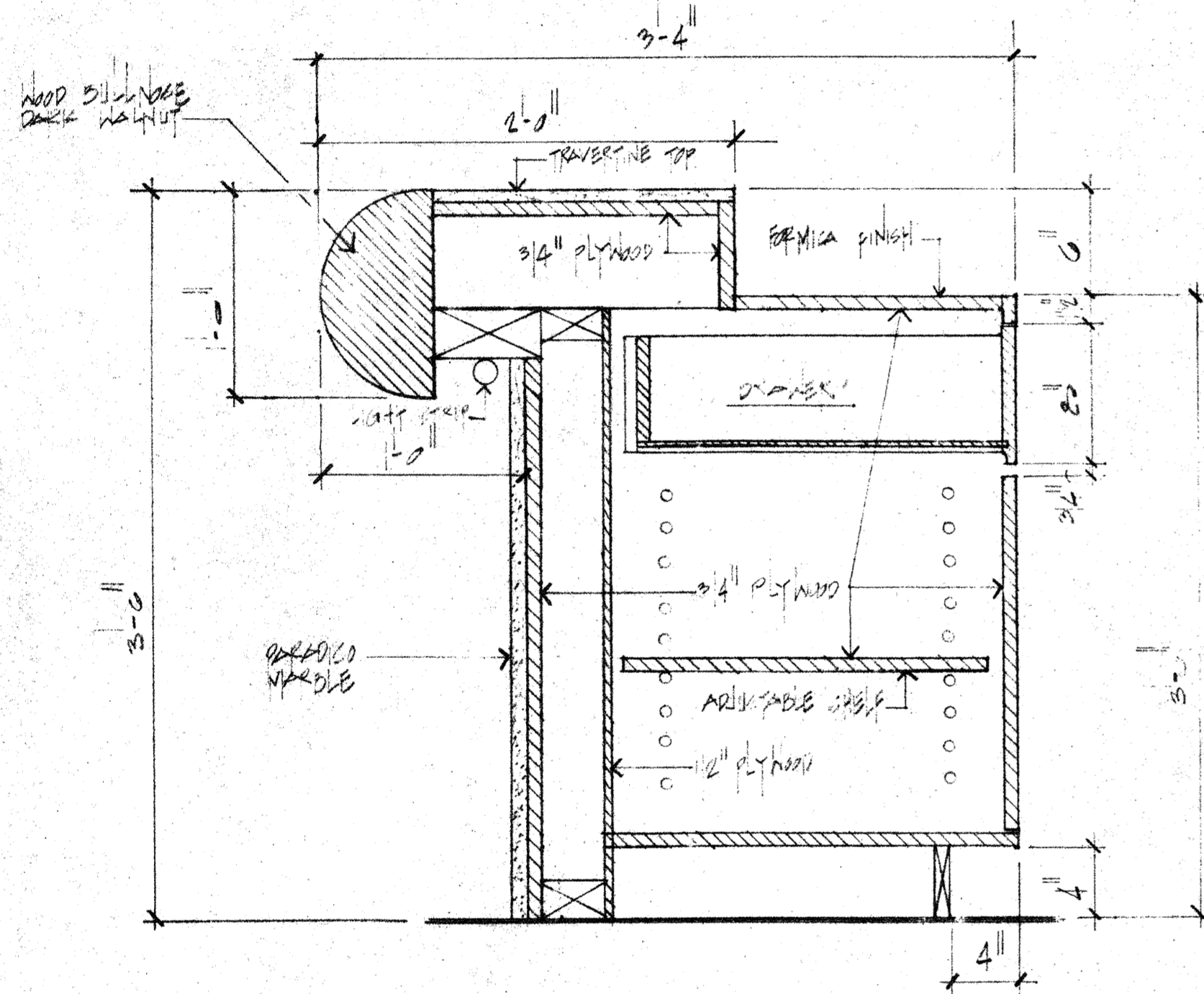

SECTION - A-A  
SCALE: 1/2" = 1'-0"

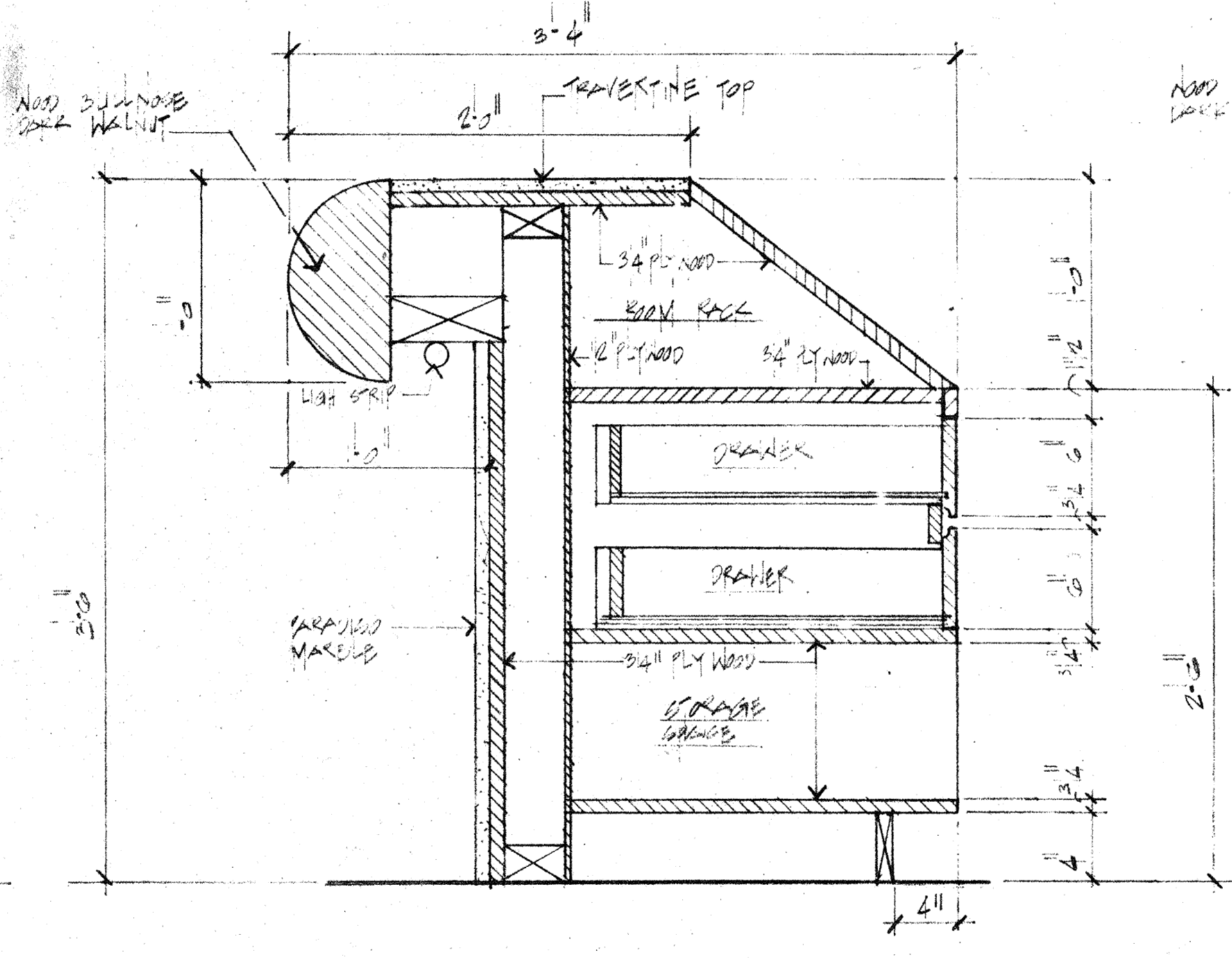

SECTION - B-B  
SCALE: 1/2" = 1'-0"

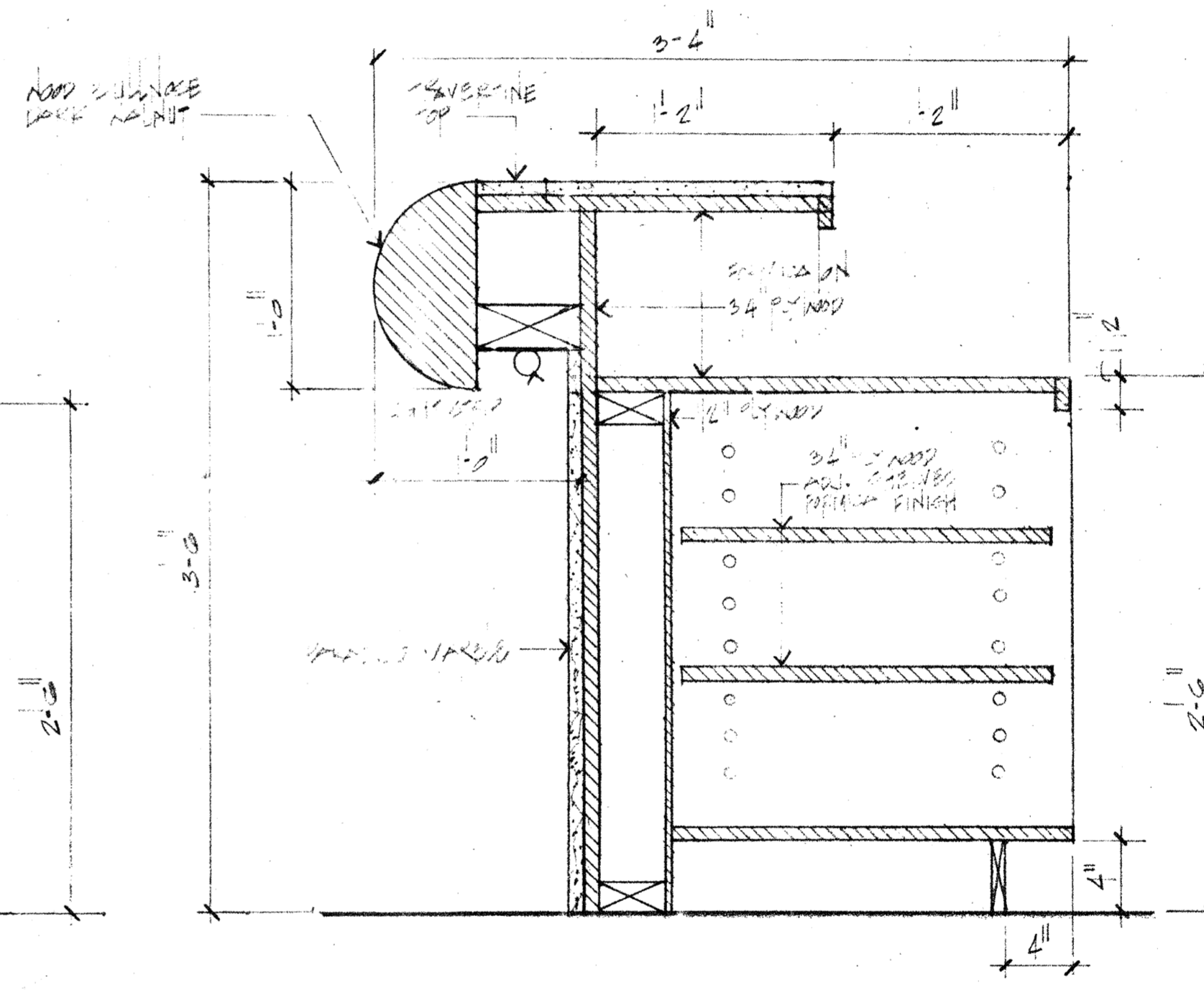

SECTION - C-C  
SCALE: 1/2" = 1'-0"

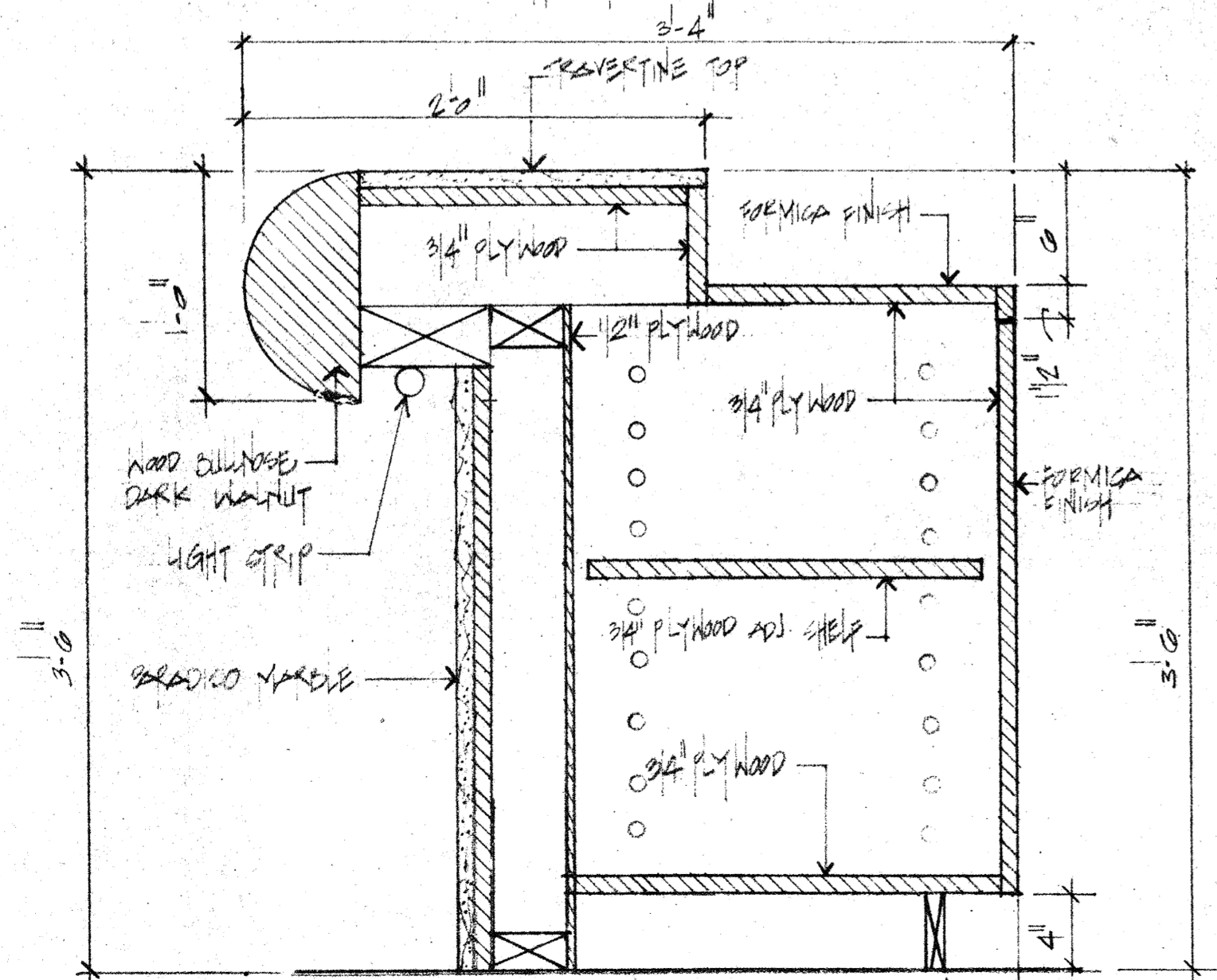

SECTION - D-D  
SCALE: 1/2" = 1'-0"

project no.  
revisions

MORRIS-POWELL ASSOCIATES, INC.  
interior designers consultants  
4500 biscayne boulevard — suite 200  
miami, florida 33137  
(305) 576-6551

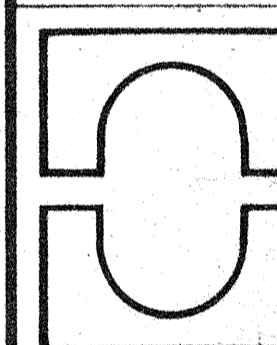

Project  
CAPITOL PLAZA HOTEL  
FRANKLIN KETTLER  
PROJECT DESK DETAILS

ID-D-105  
sheet  
scale  
date 5/21/59

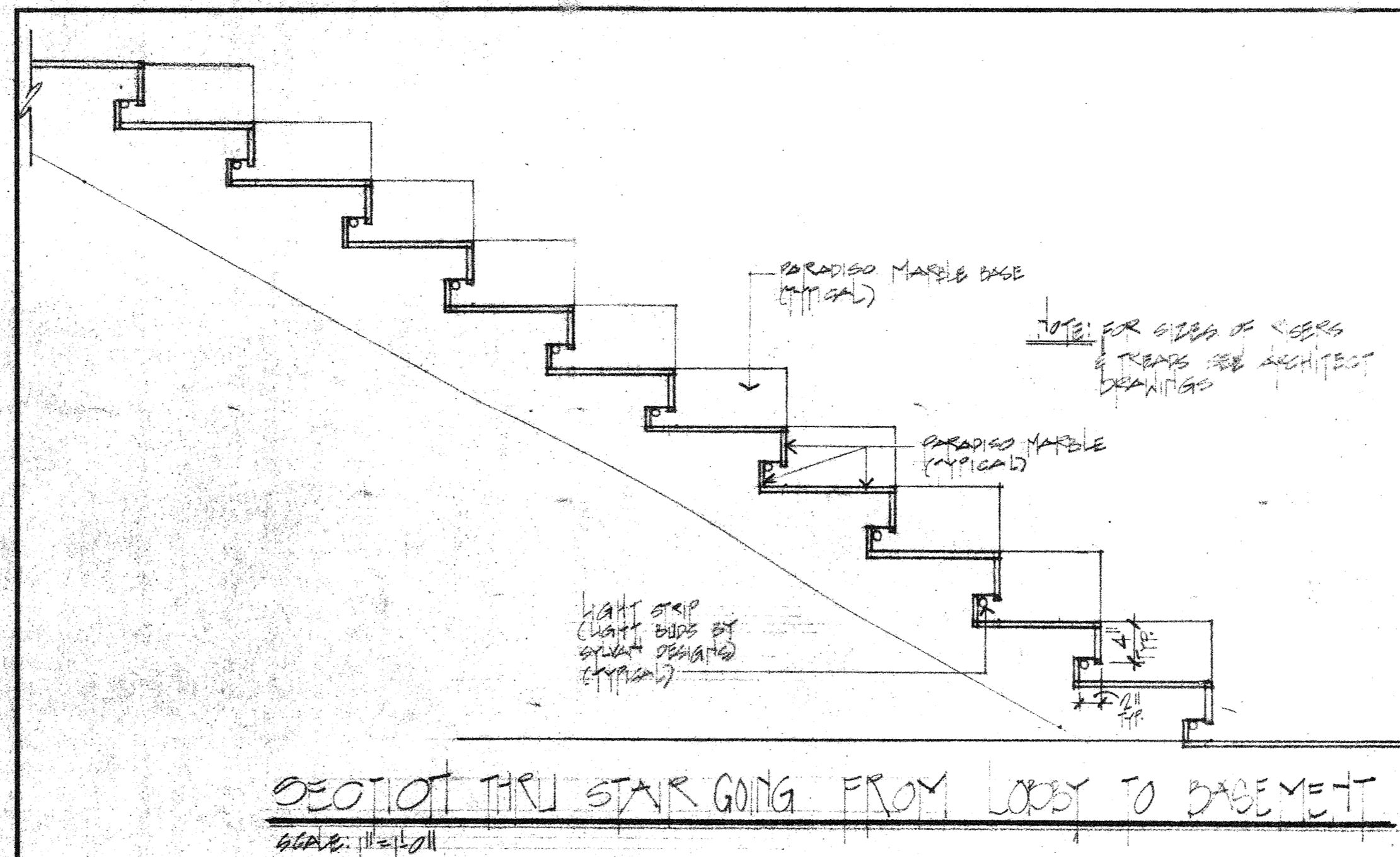

SECTION THRU STAIR GOING FROM LOBBY TO BASEMENT  
SCALE: 1/4" = 1'-0"

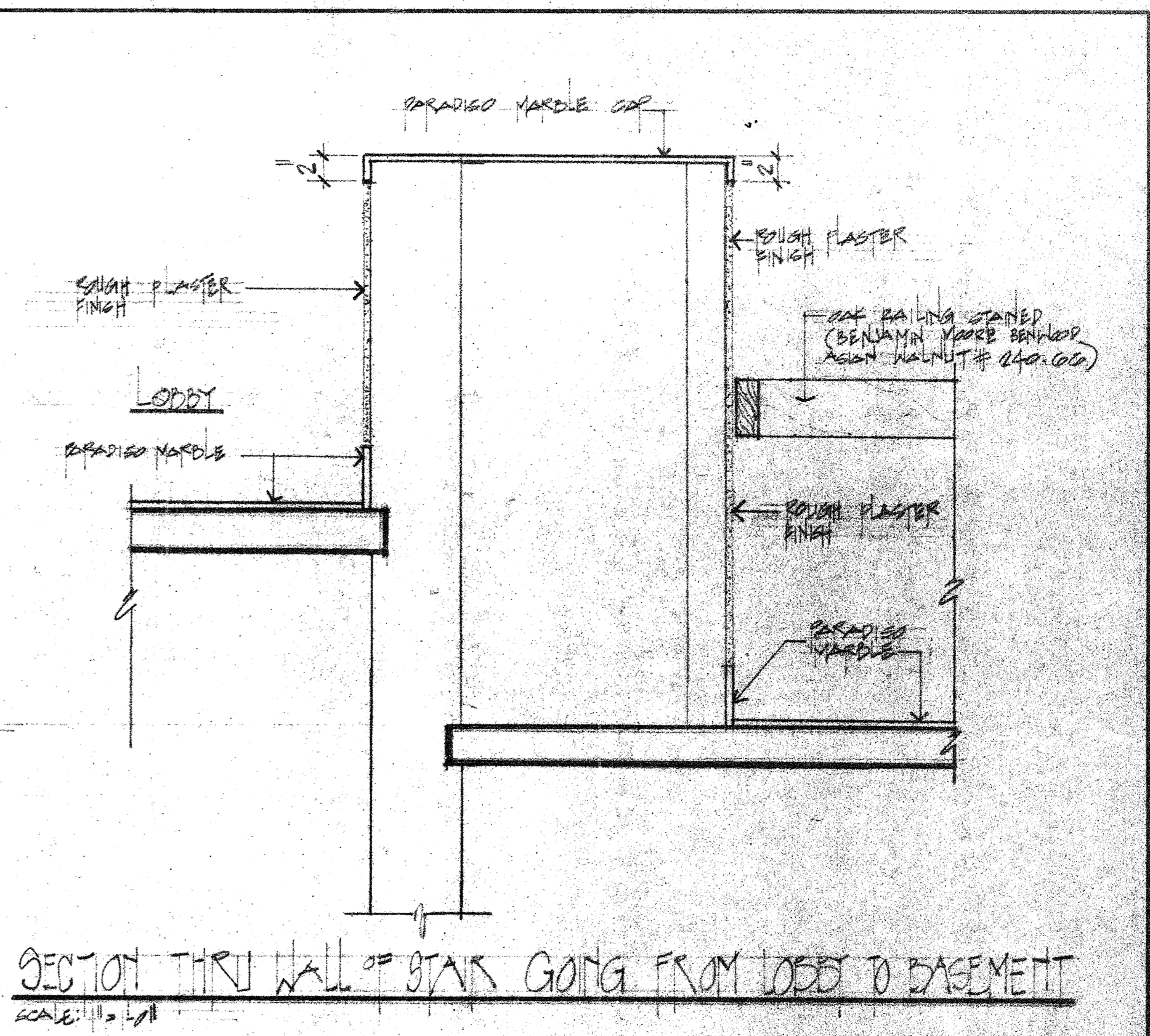

SECTION THRU WALL OF STAIR GOING FROM LOBBY TO BASEMENT  
SCALE: 1/4" = 1'-0"

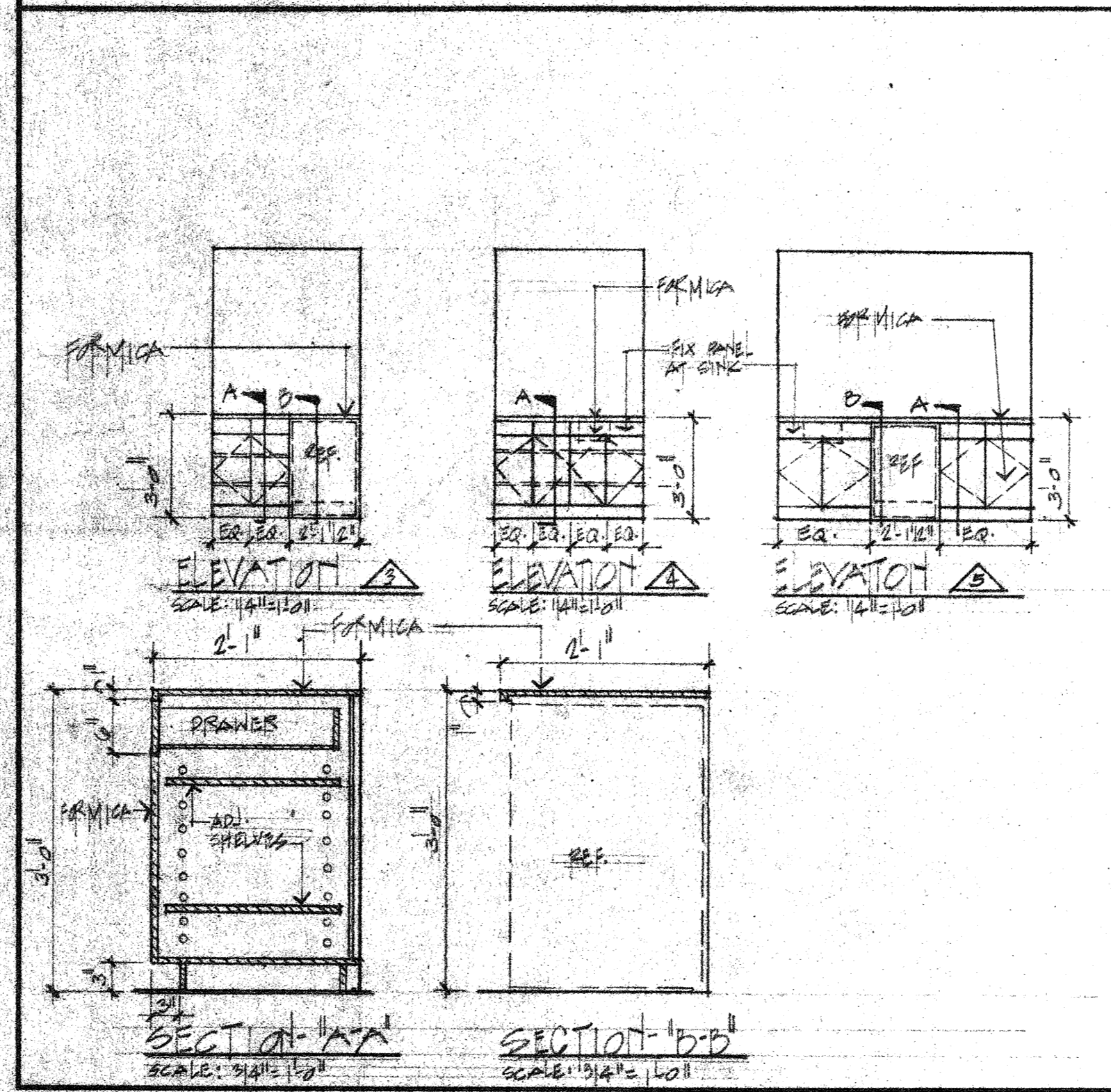

SECTION 'A-A' SCALE: 3/4\"/>

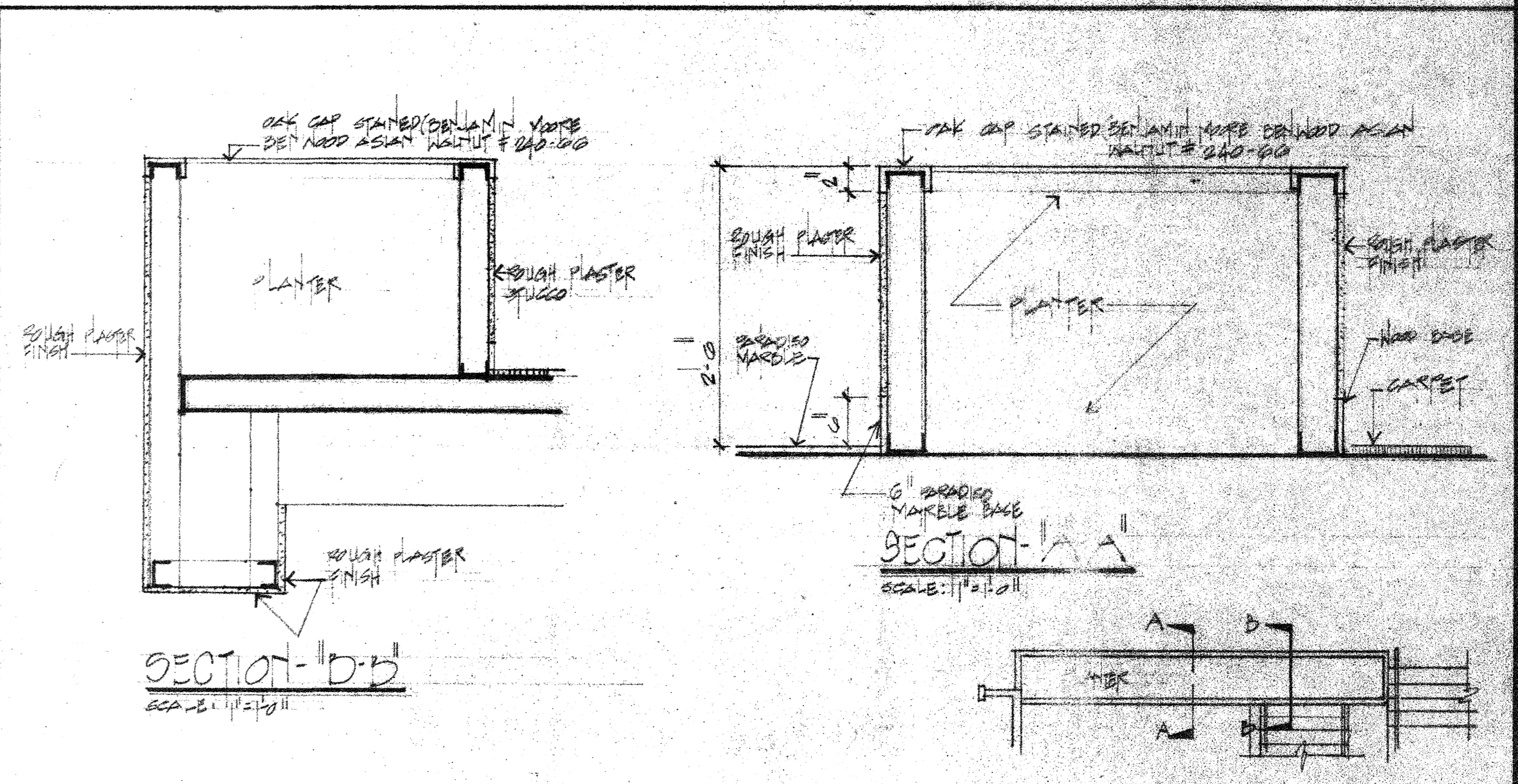

SECTION-D-D  
SCALE: 1/4\"/>

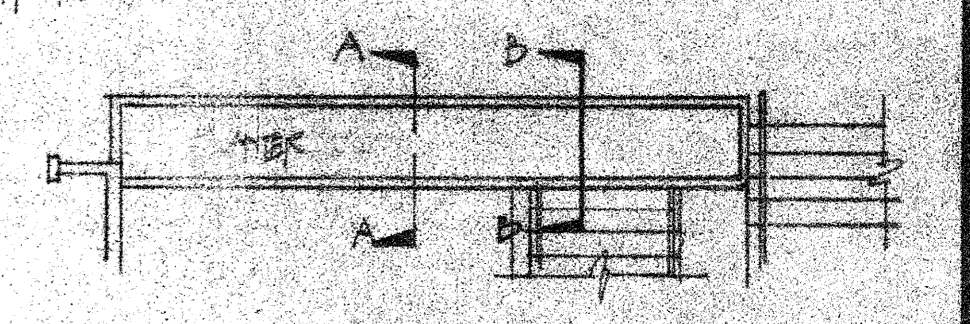

project no. \_\_\_\_\_  
 revisions \_\_\_\_\_

MORRIS-POWELL ASSOCIATES, INC.  
 interior designers consultants  
 2699 biscayne boulevard suite 2  
 miami, florida 33137  
 (305) 576-6551

Project  
 CAPITOL PLAZA HOTEL  
 FINLANDIA BUILDING  
 GENERAL DETAILS

ID-D-100  
 sheet  
 scale  
 date

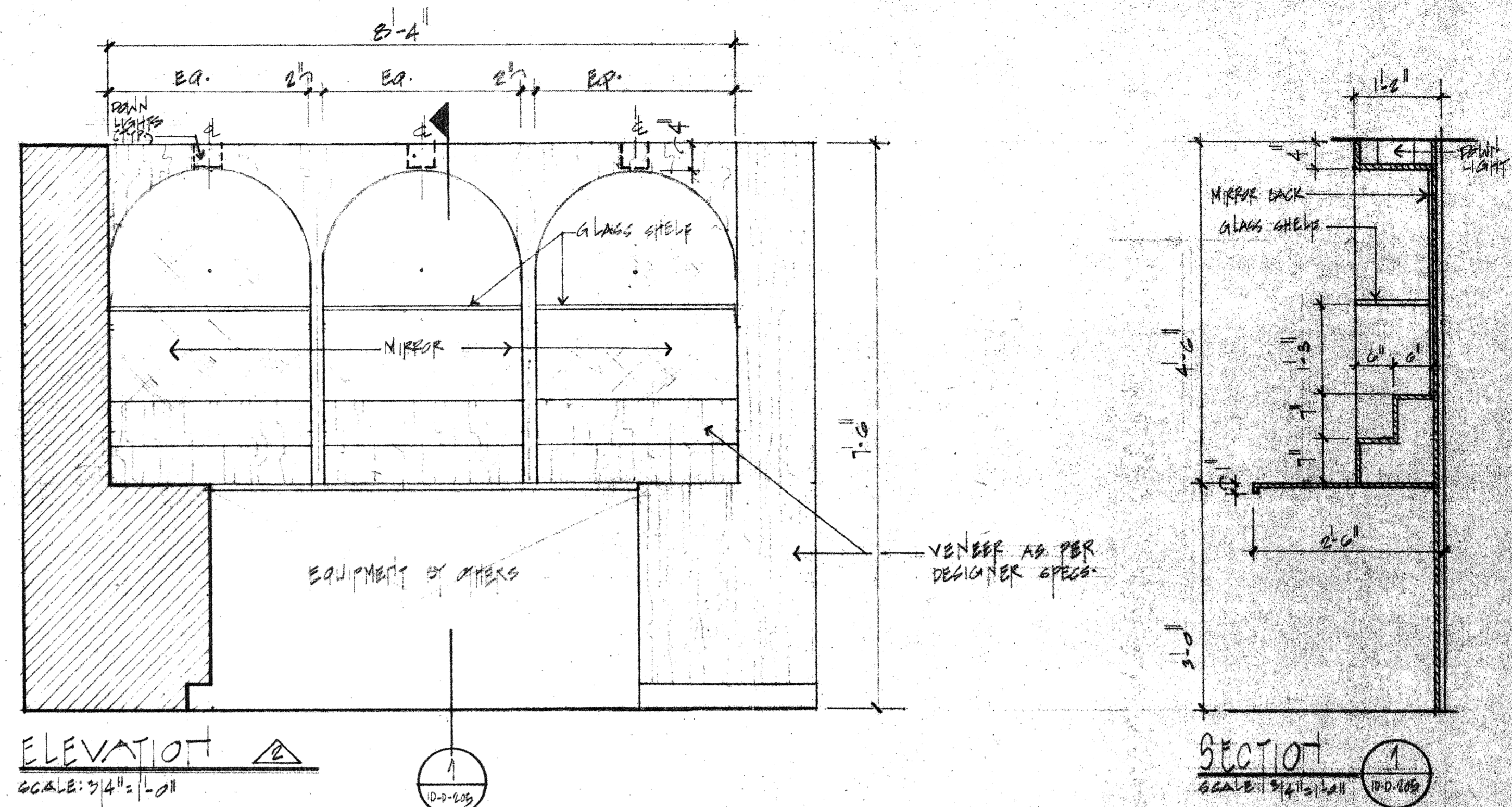
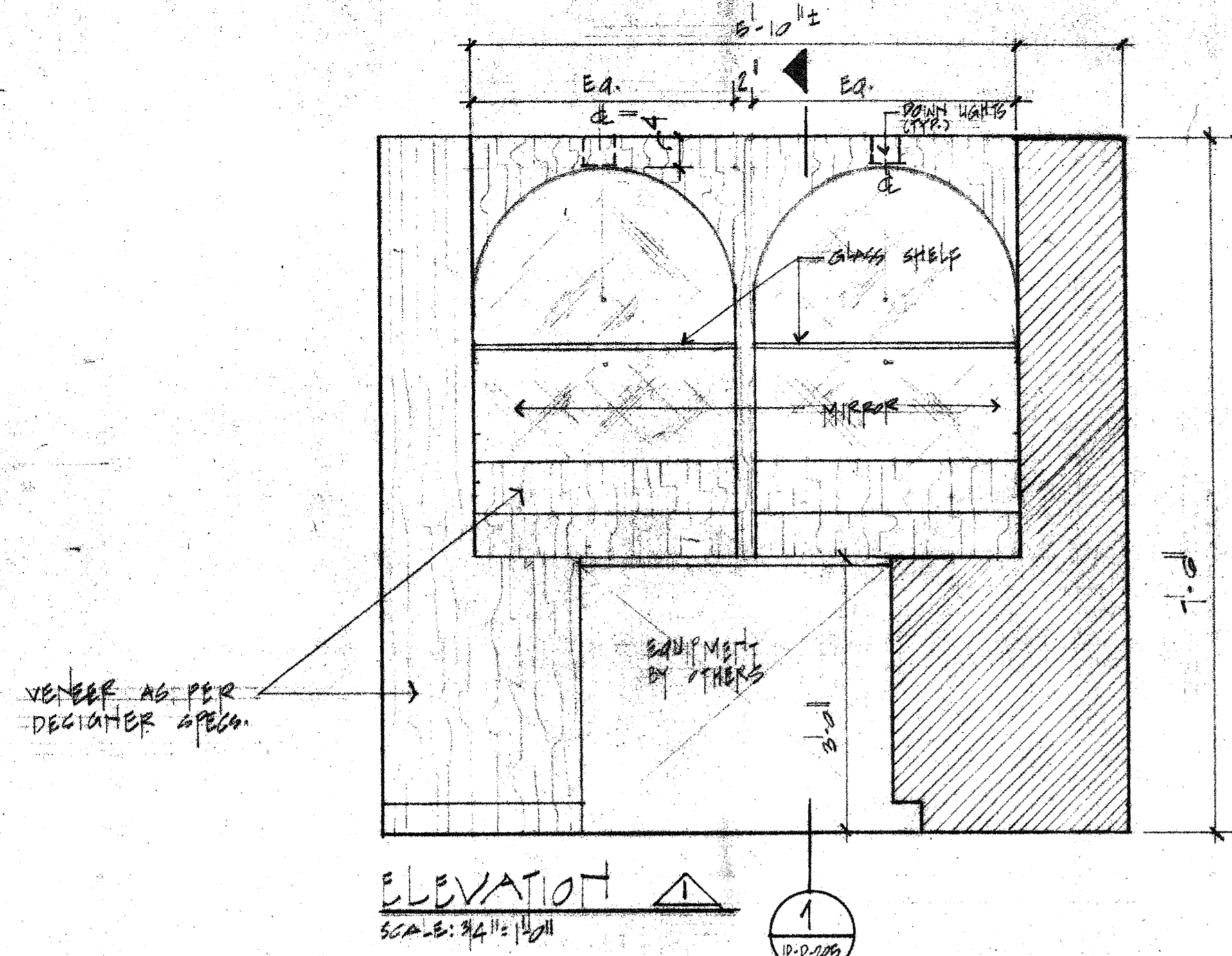
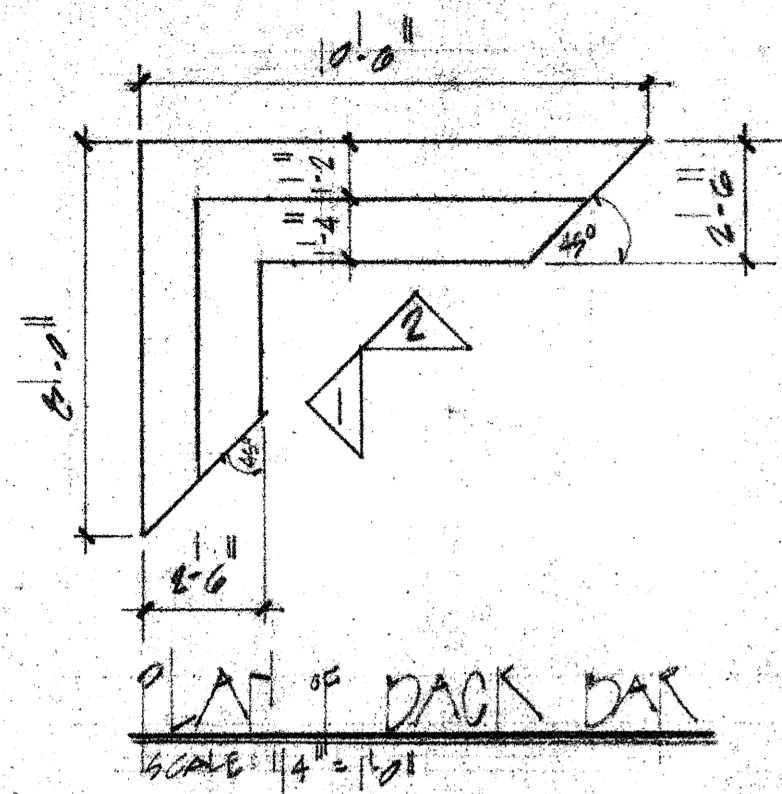

DETAIL

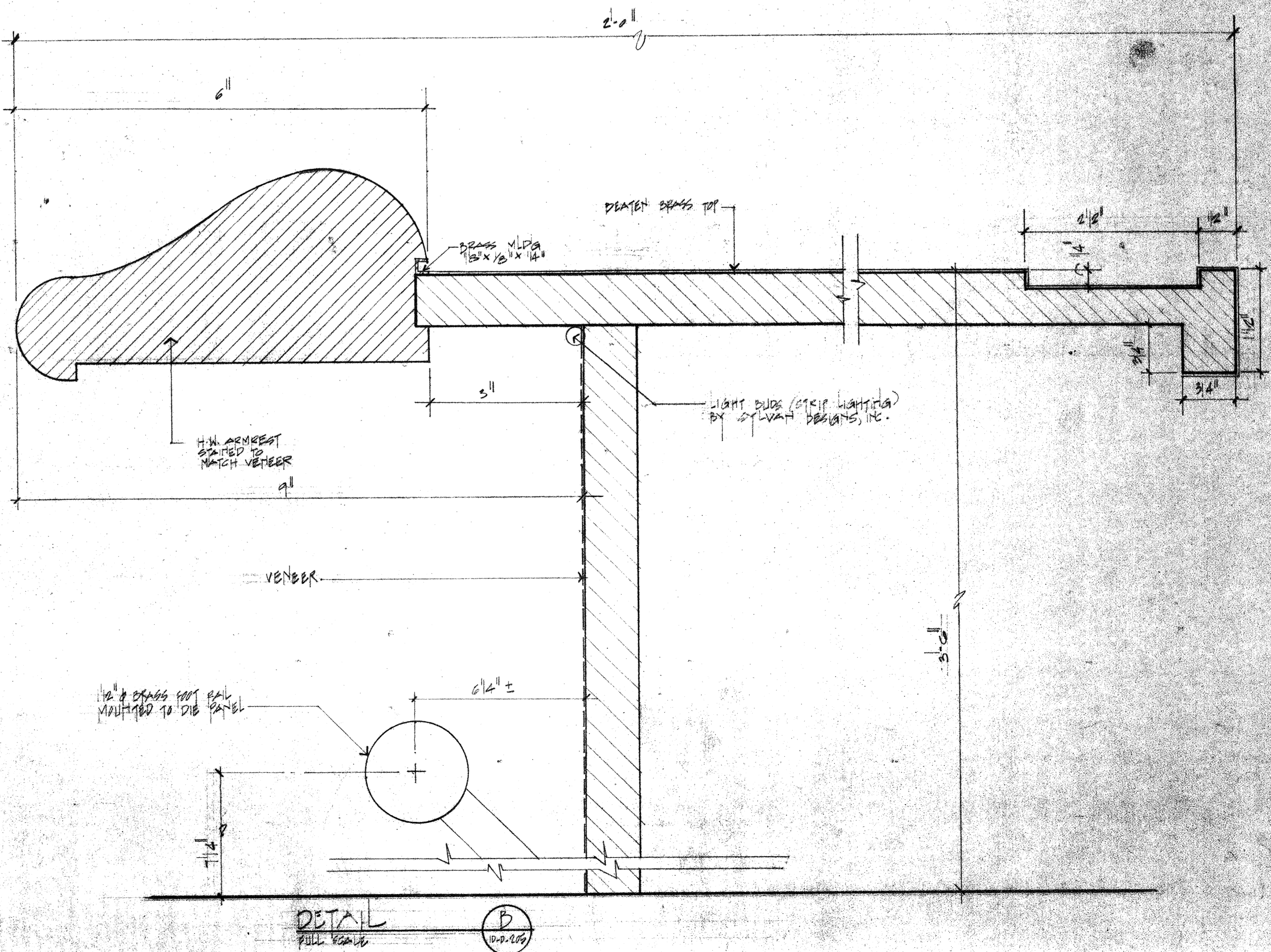
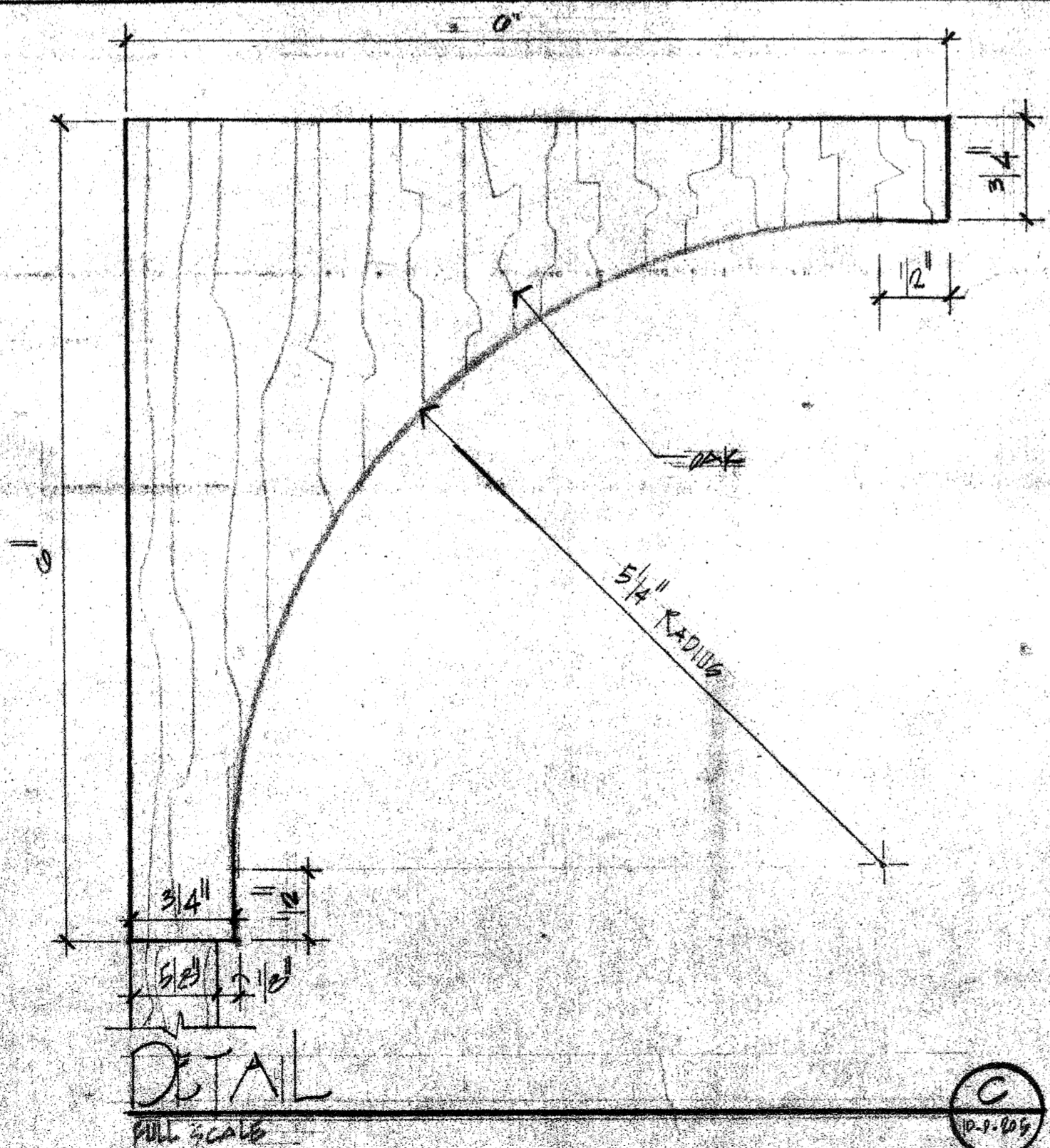
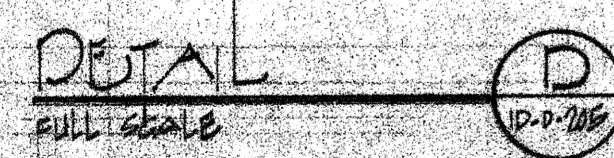
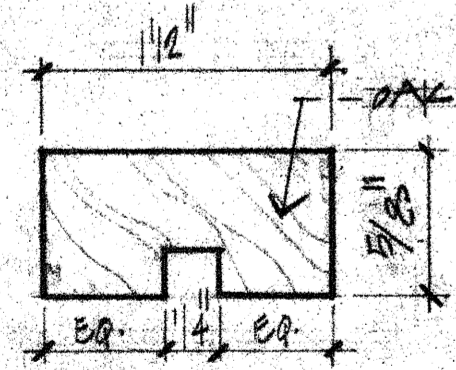
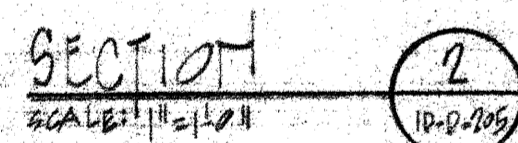
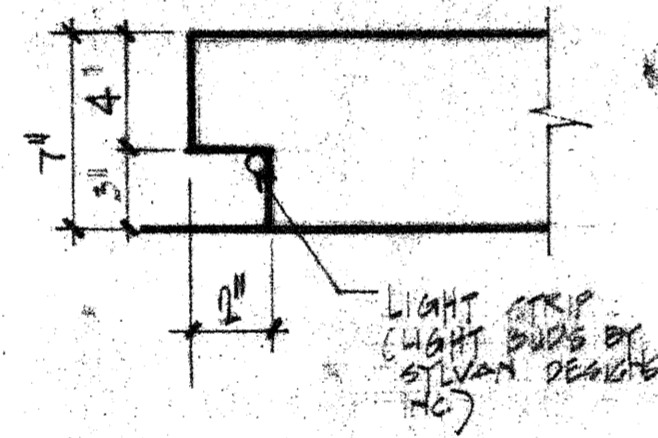
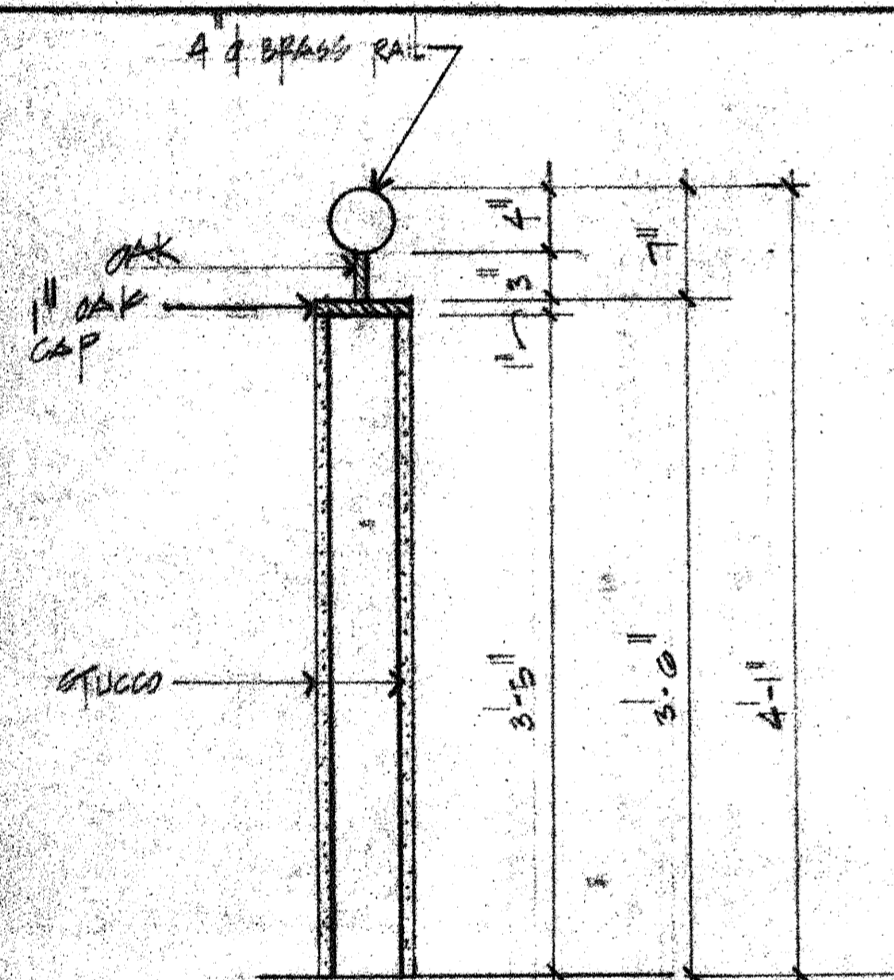

project no. revisions  
 MORRIS-POWELL ASSOCIATES, INC. consultants  
 interior designers  
 4500 biscayne boulevard — suite 200  
 miami, florida 33137  
 (305) 576-6551

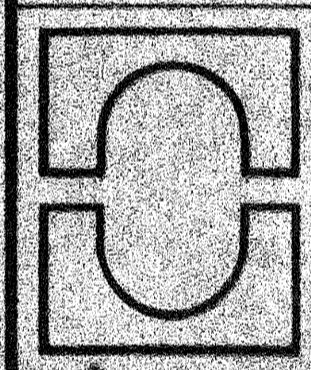

Project  
 CAPITOL PLAZA HOTEL  
 FRANKFORT, KENTUCKY  
 UPPER LOBBY BAR - DETAILS

R. D. 205  
 sheet  
 scale: AS SHOWN  
 date: 6-7-83

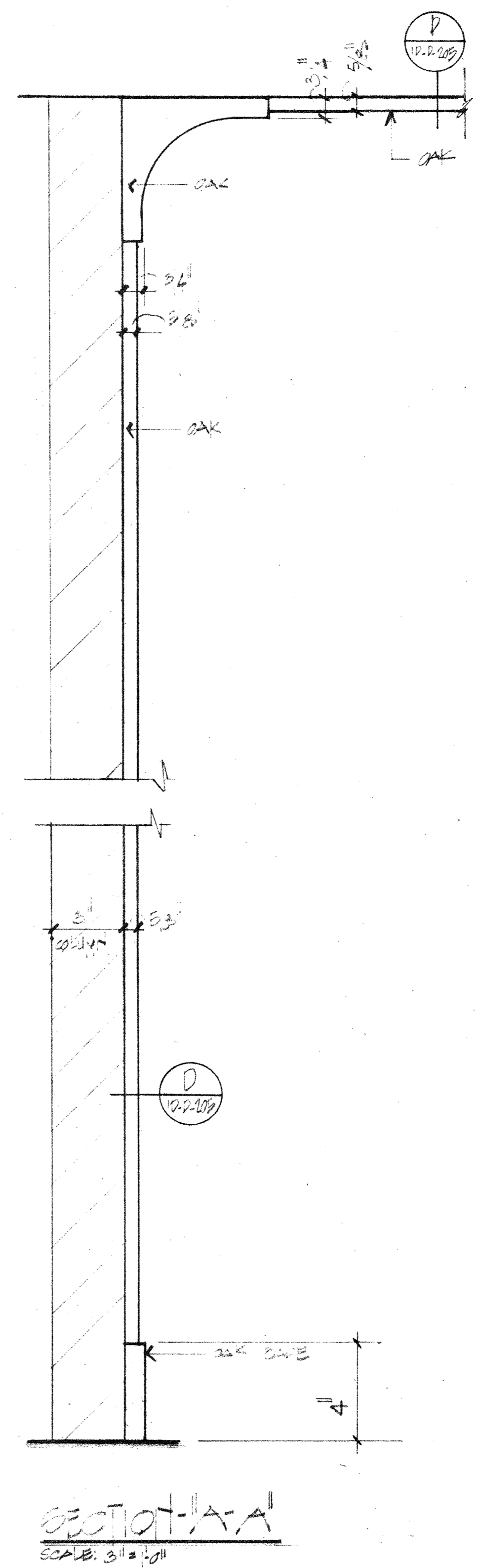
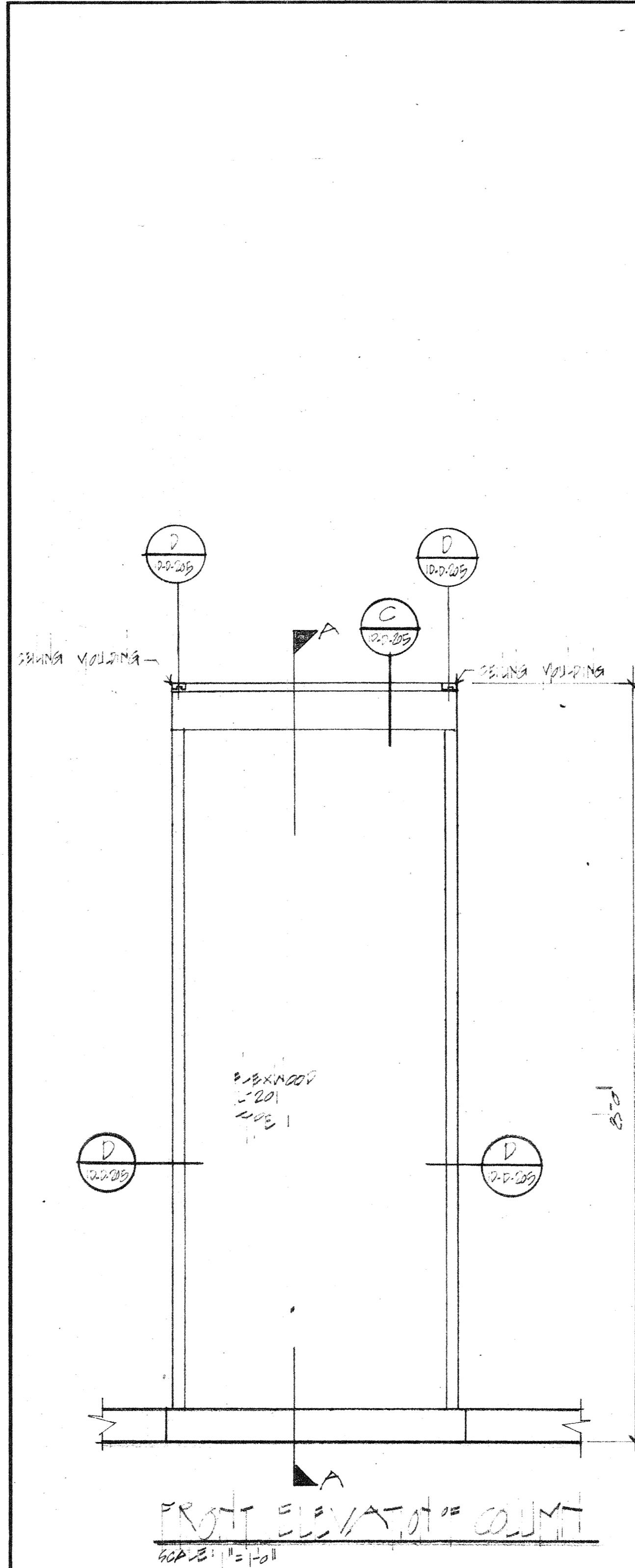

P.D.-006  
sheet 1 of 1  
scale: AS SHOWN  
date 5-18-83

Project  
CAPTOL STAYA HOTEL  
FRANKLIN CENTER  
WOOD BRICK COLUMN DETAILS

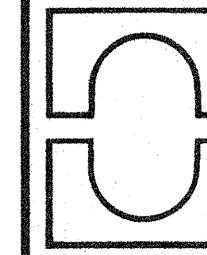

MORRIS-POWELL ASSOCIATES, INC.  
interior designers consultants  
2699 biscayne boulevard suite 2  
miami, florida 33137  
(305) 576-6551

Project no.  
revisions

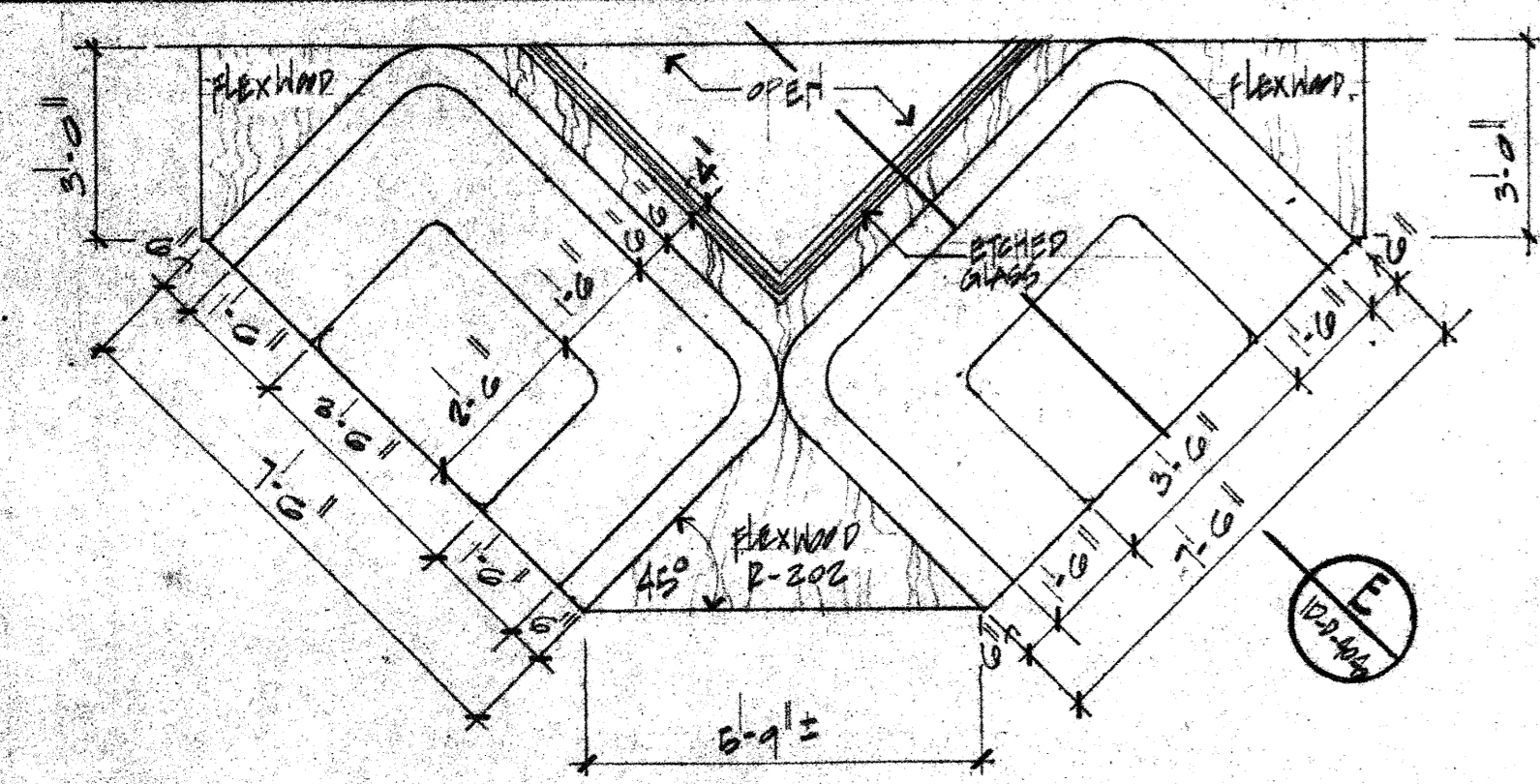
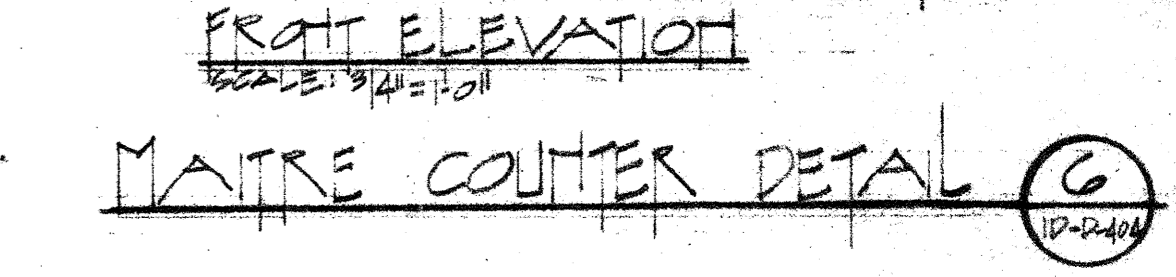
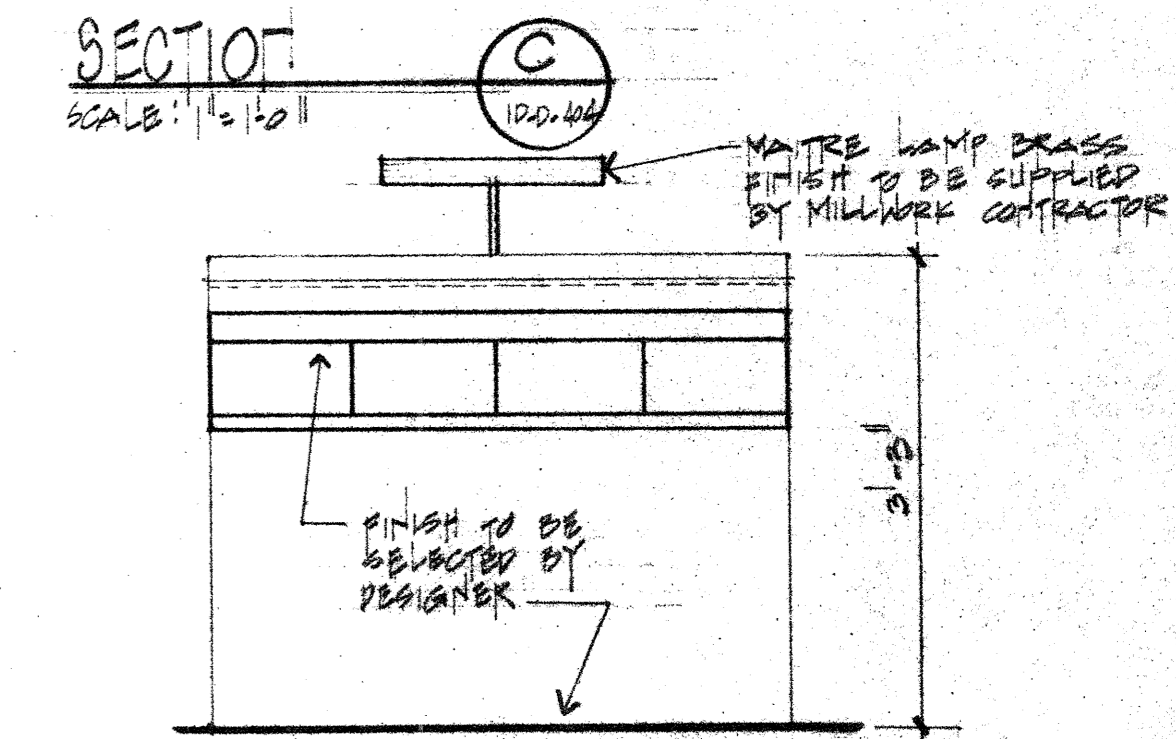
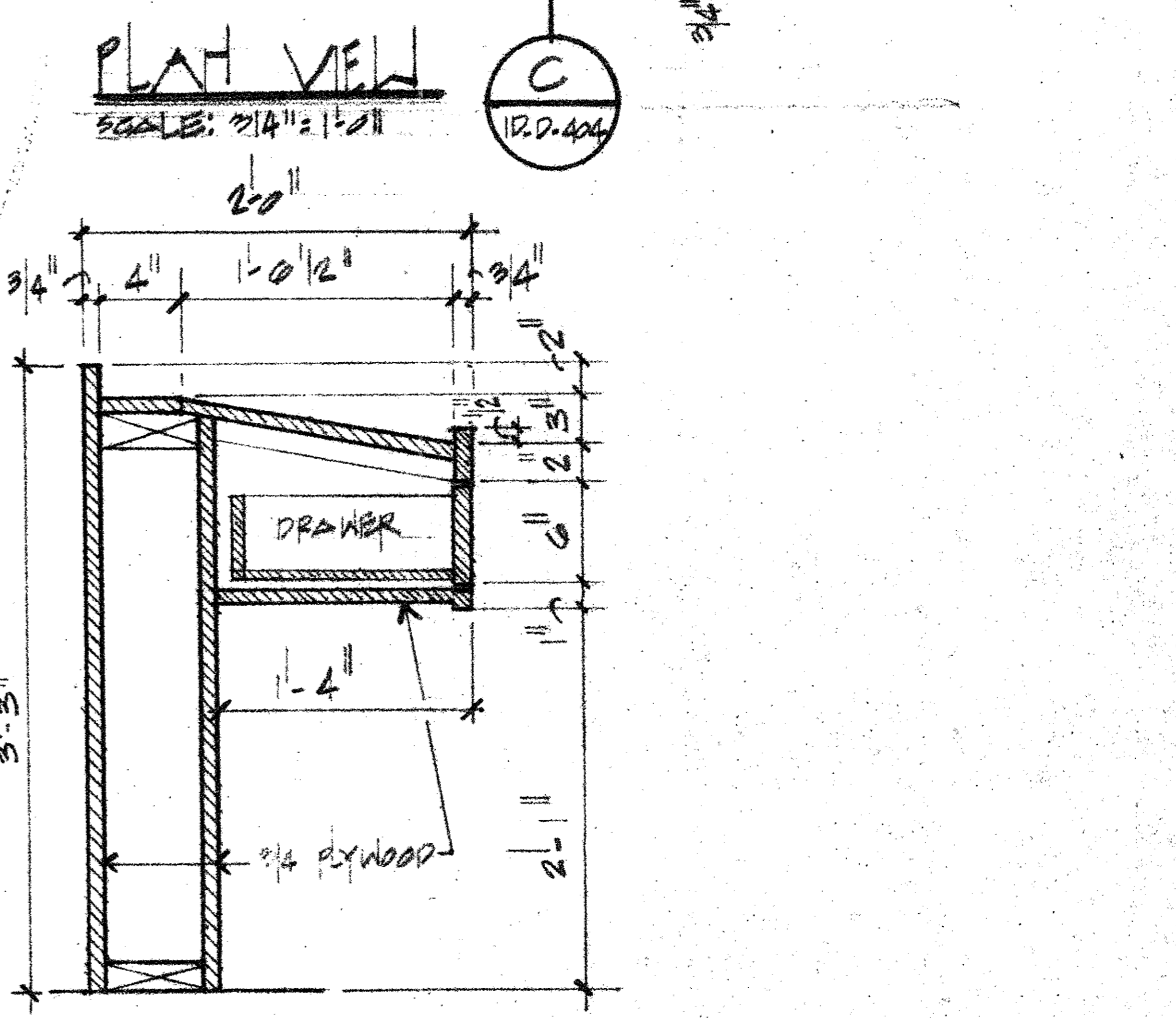
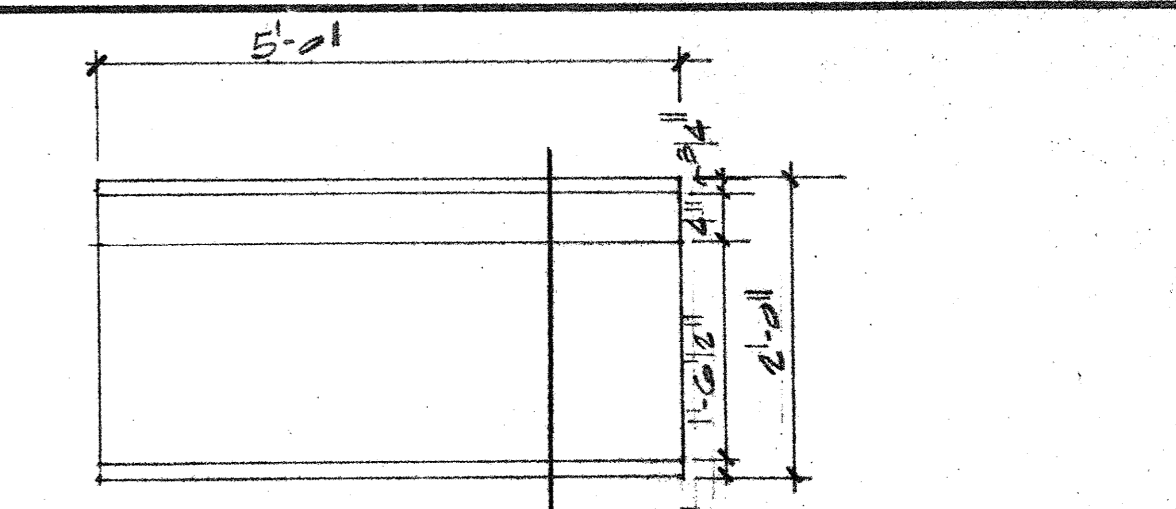
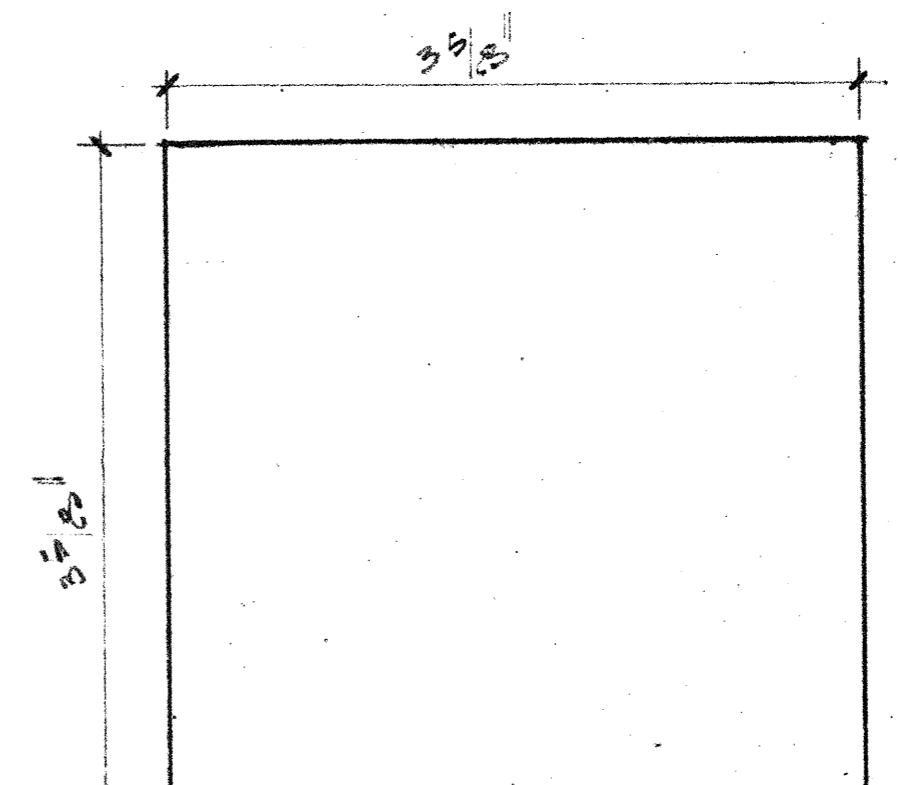
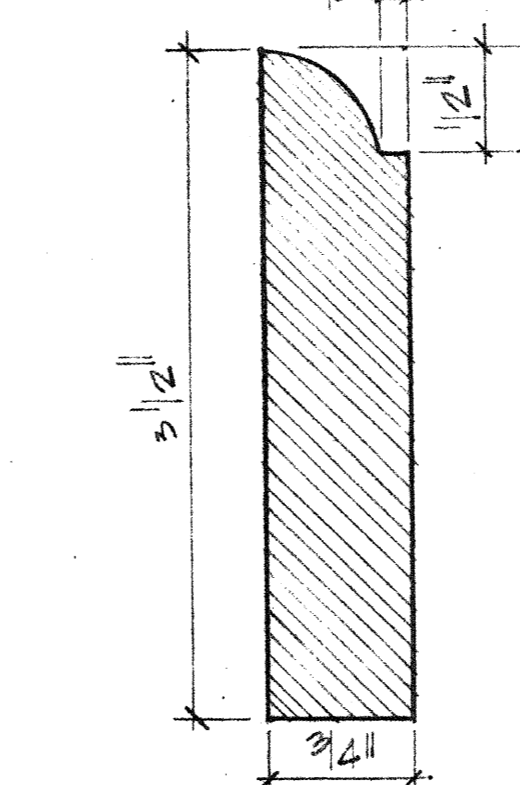
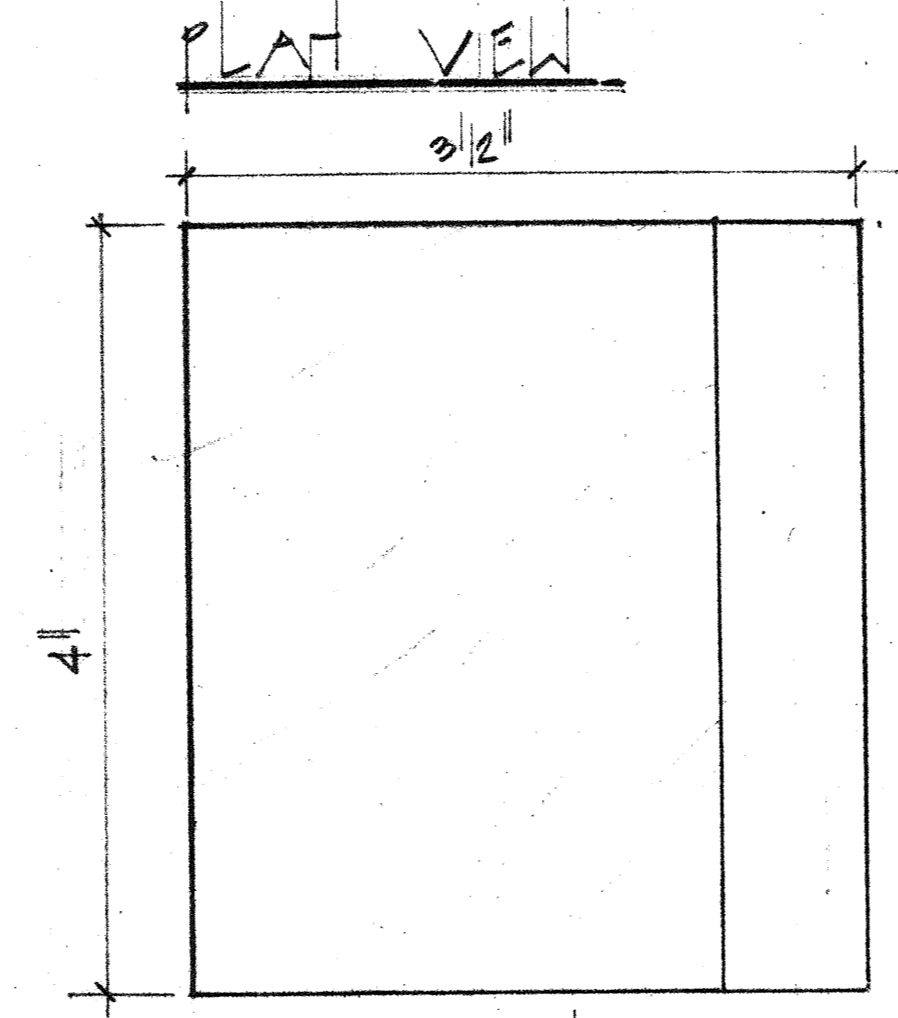
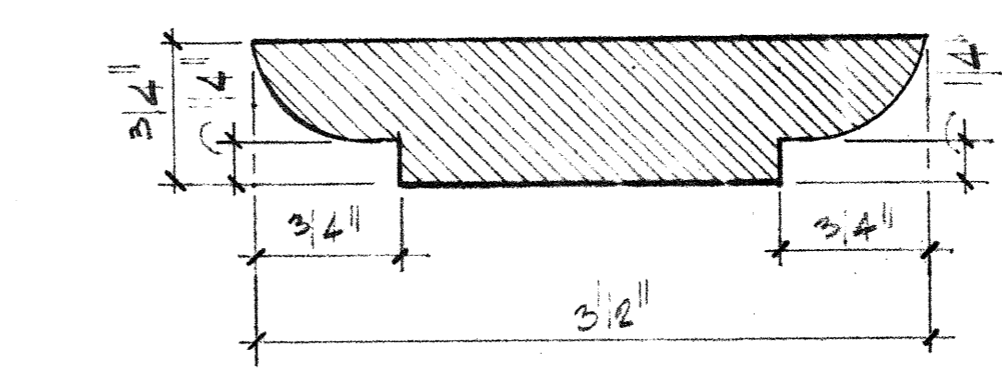
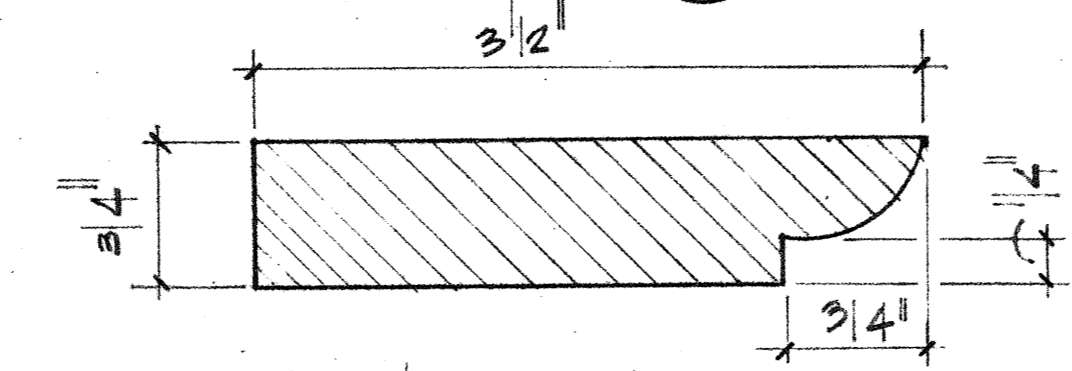
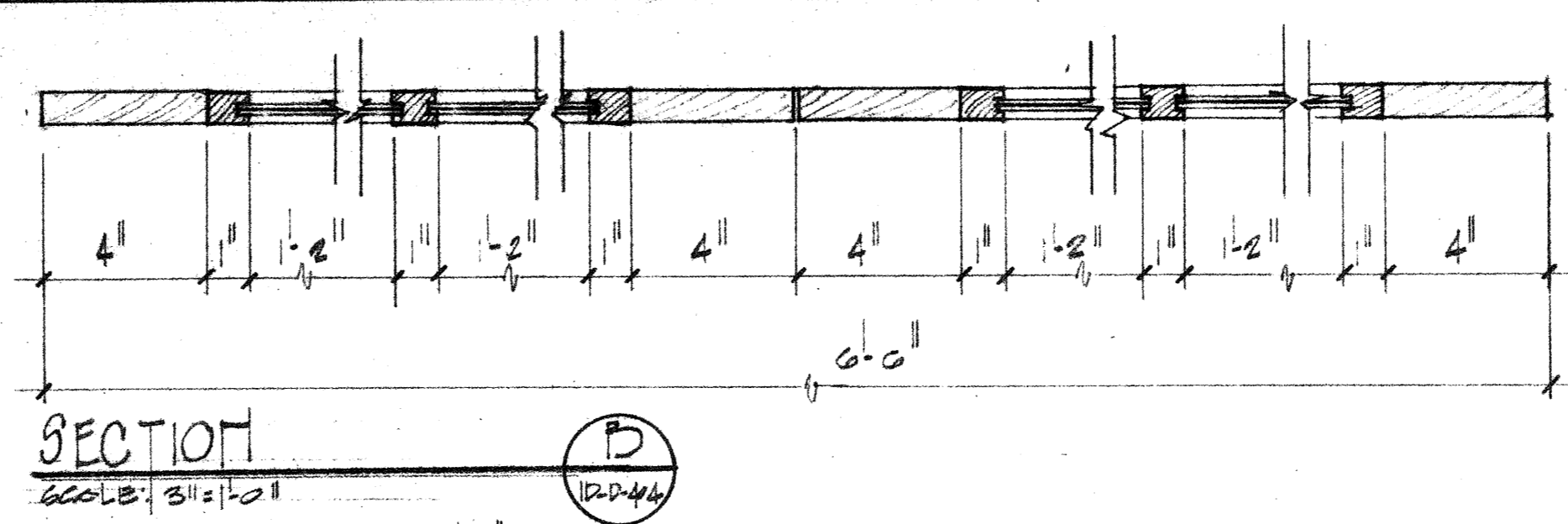
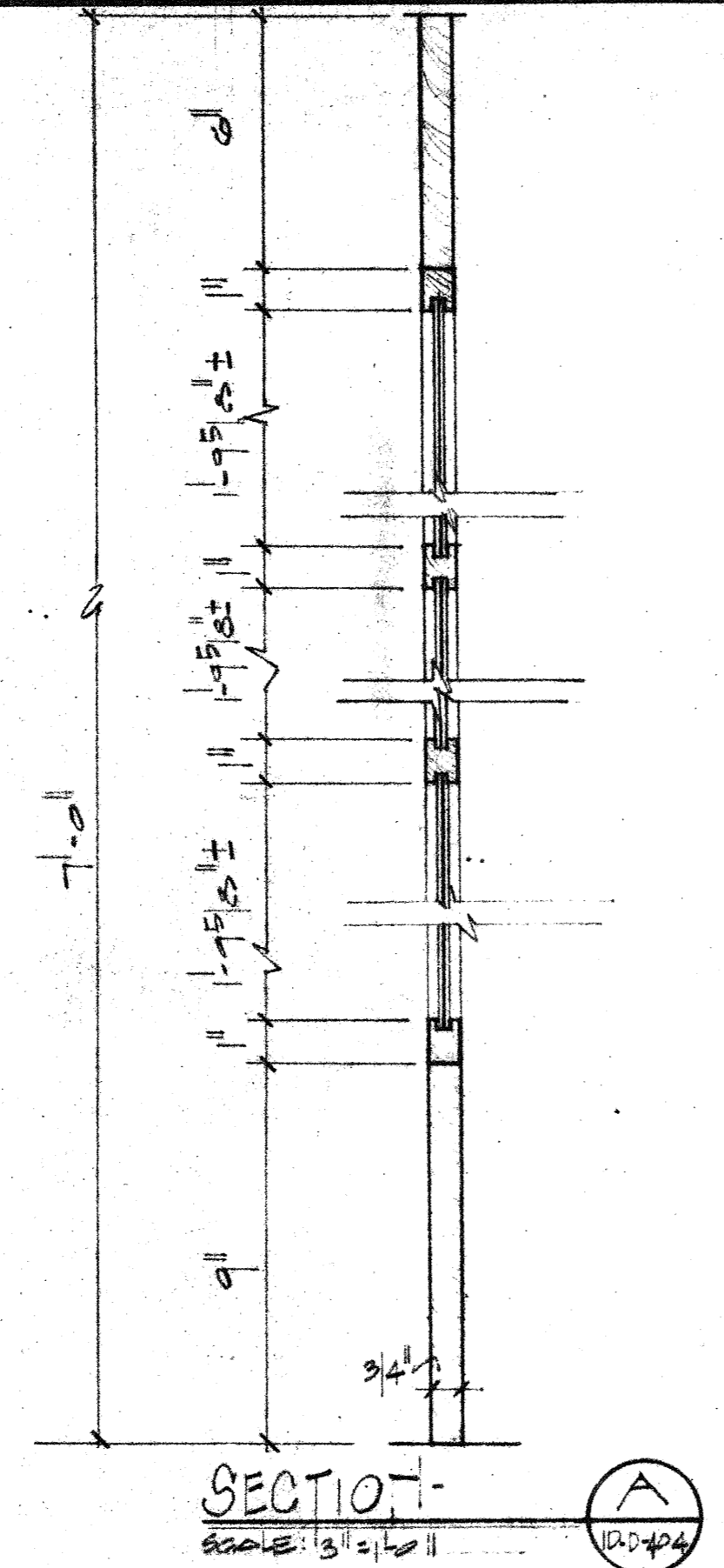
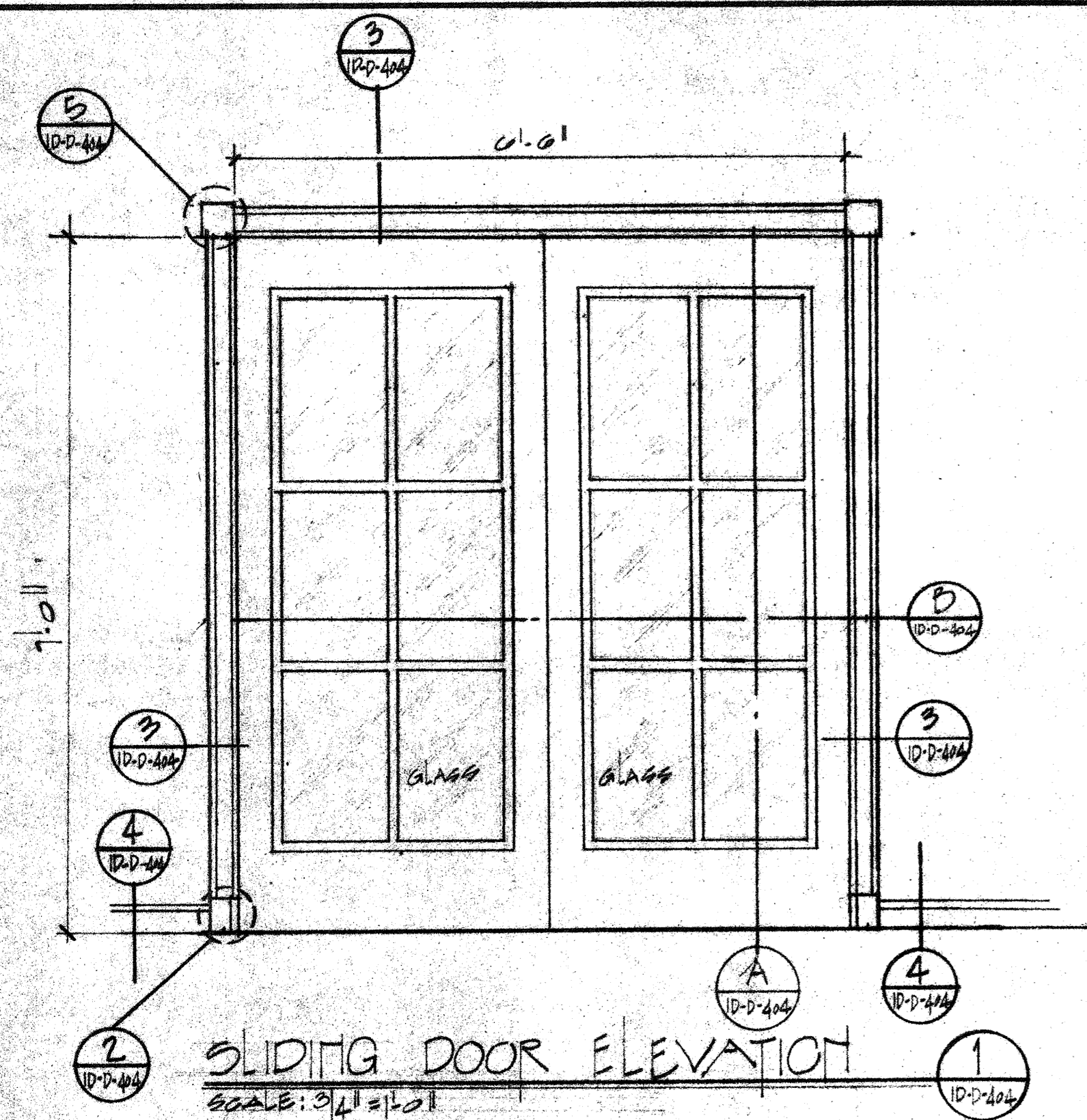

**DOUBLE BANQUETTE DETAIL AT GOURMET**  
SCALE: 3/4" = 1'-0"

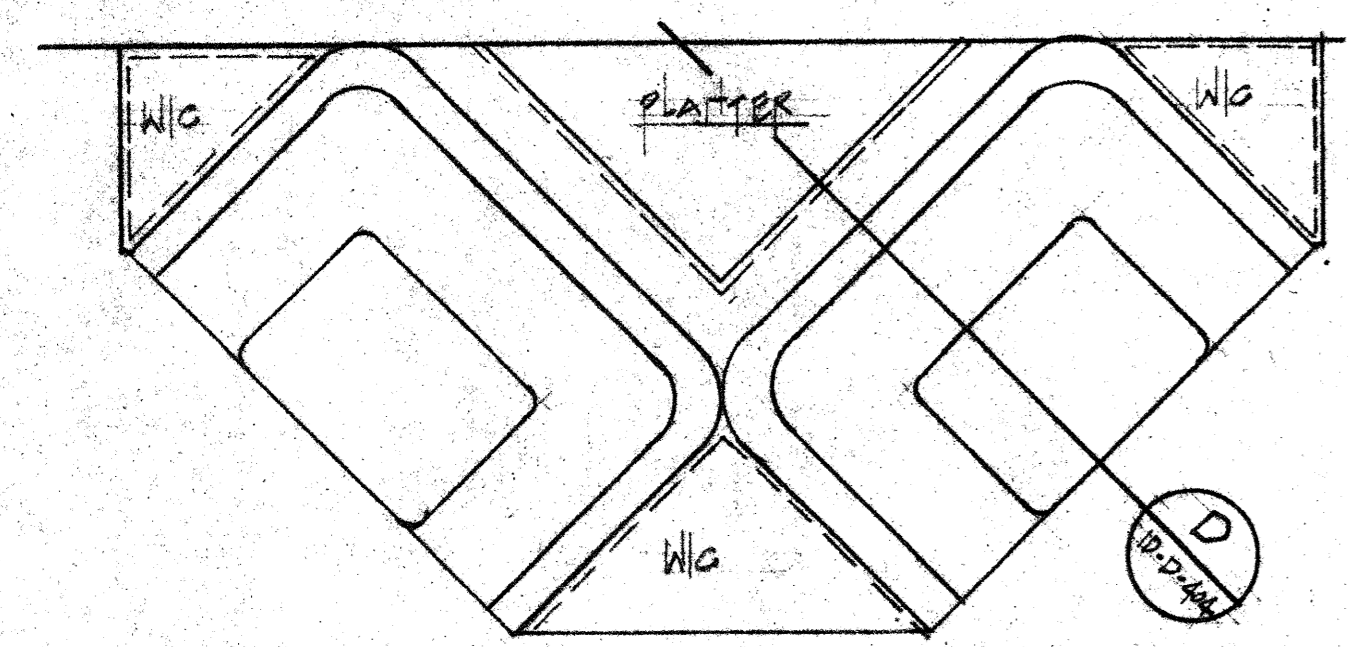

**DOUBLE BANQUETTE DETAIL AT RESTAURANT**  
SCALE: 3/4" = 1'-0"

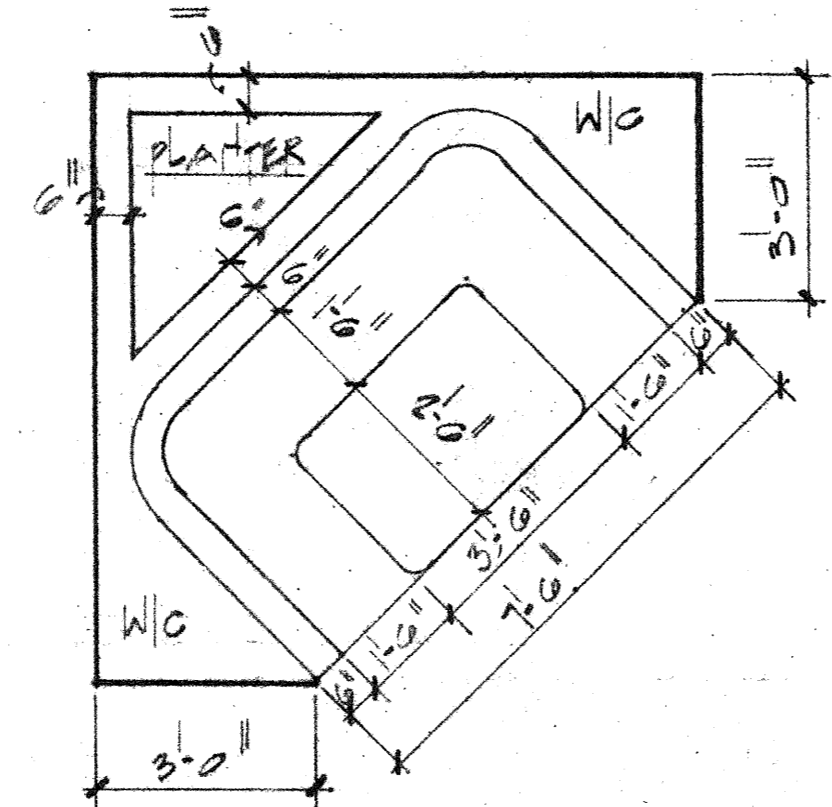

**SINGLE BANQUETTE DETAIL AT RESTAURANT**  
SCALE: 3/4" = 1'-0"

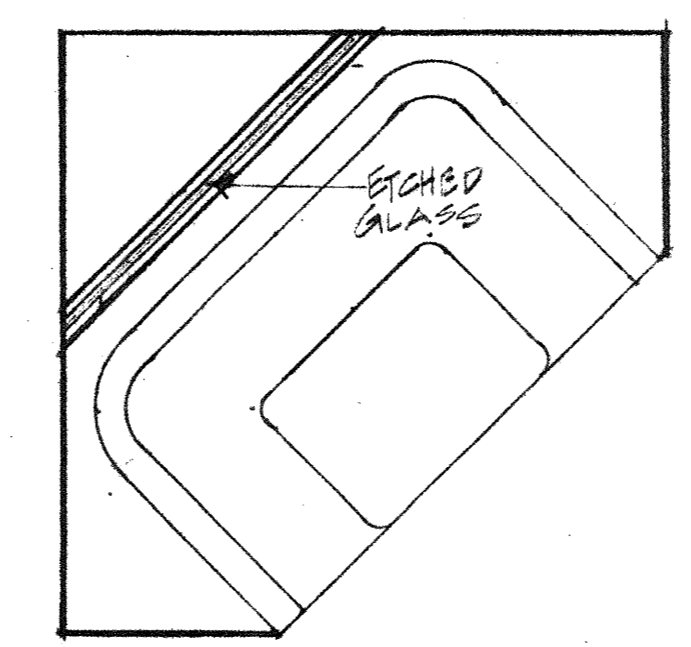

**SINGLE BANQUETTE DETAIL AT GOURMET**  
SCALE: 3/4" = 1'-0"

NOTE: MILLWORK SUB-CONTRACTOR TO SUPPLY ALL WORK ABOVE BANQUETTES  
BANQUETTES MANUFACTURER TO SUPPLY COMPLETE UNIT BELOW AS SHOWN.

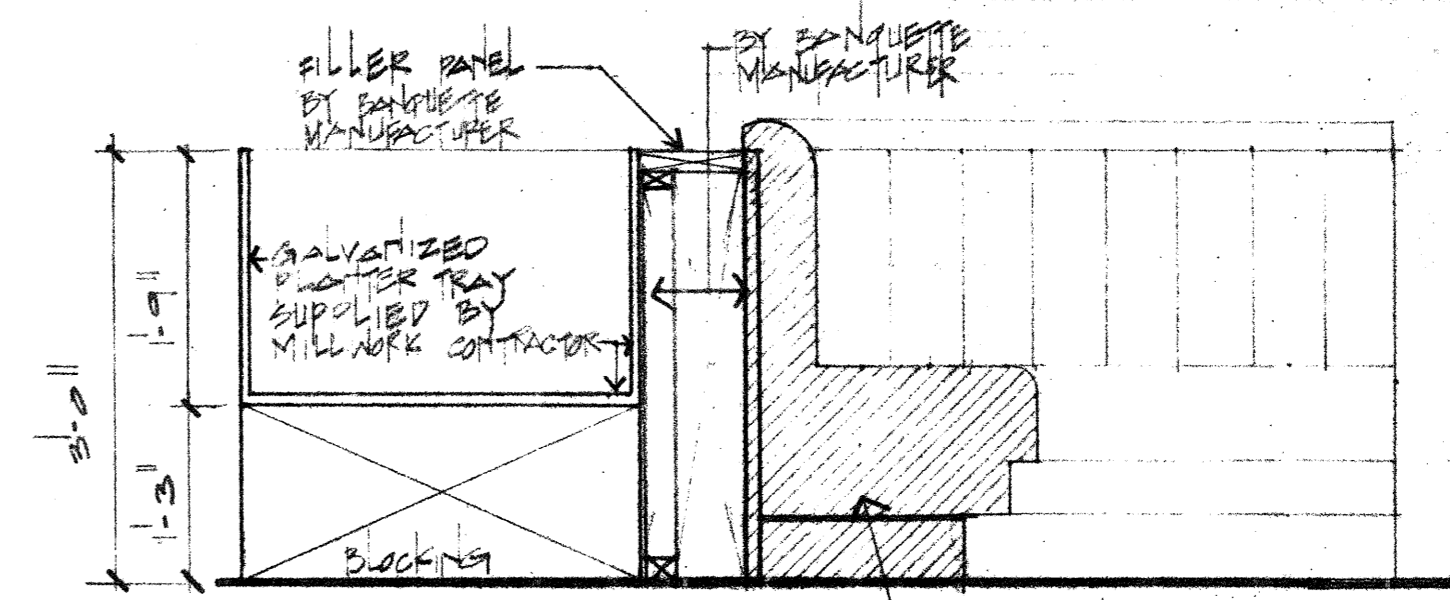

**SECTION**  
SCALE: 3/4" = 1'-0"

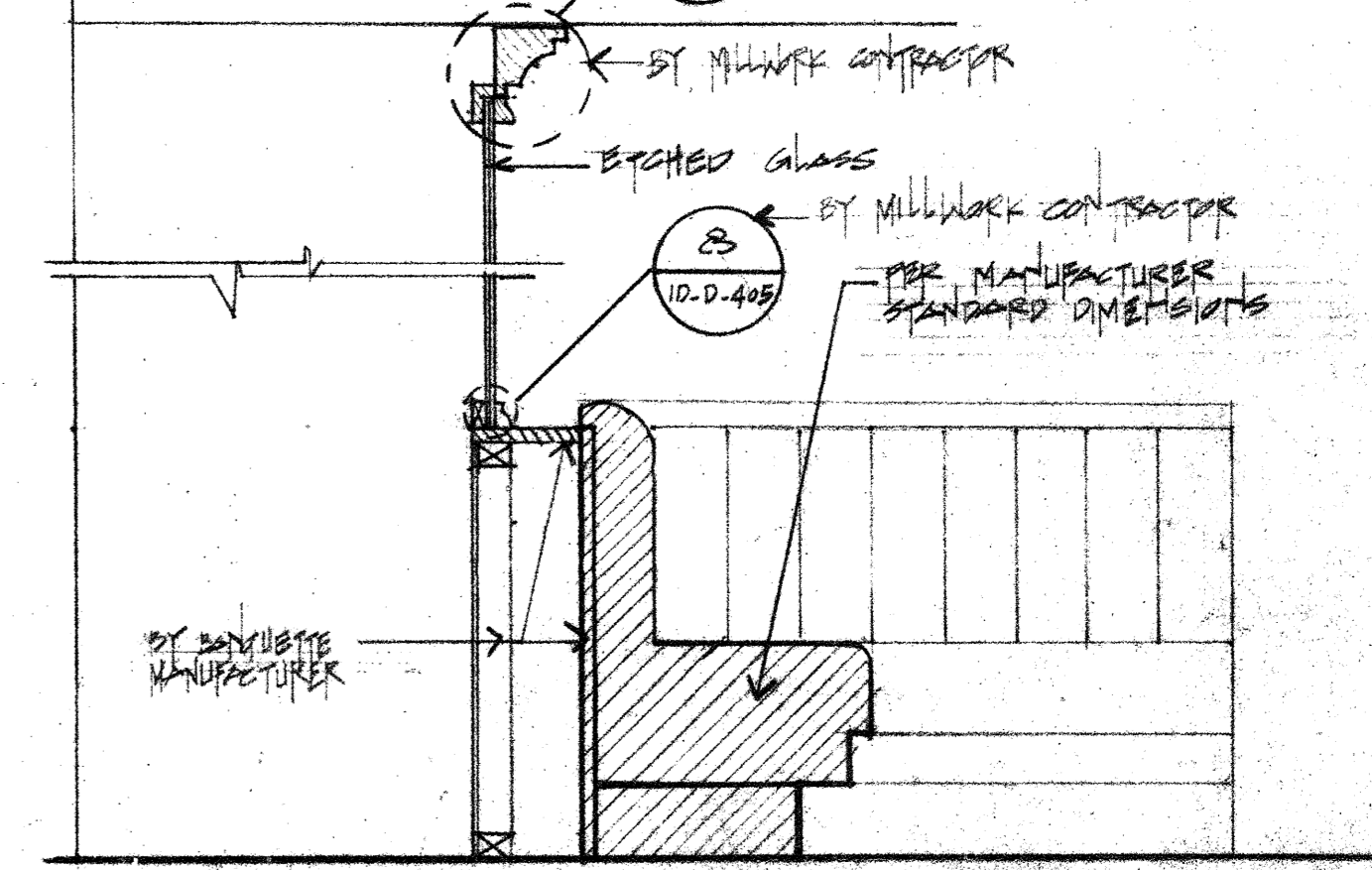

**SECTION**  
SCALE: 3/4" = 1'-0"

project no. 10-D-404  
revisions  
① 6-6-83  
② 7-7-83  
③ 8-18-83

**MORRIS-POWELL ASSOCIATES, INC.**  
interior designers consultants  
4500 biscayne boulevard suite 200  
miami, florida 33137  
(305) 576-6551

project **CAPITOL PLAZA HOTEL**  
**FRANKFORT/KENTUCKY**  
**RESTAURANT-DETAILS**

**10-D-404**  
sheet  
scale AS SHOWN  
date 5-17-83



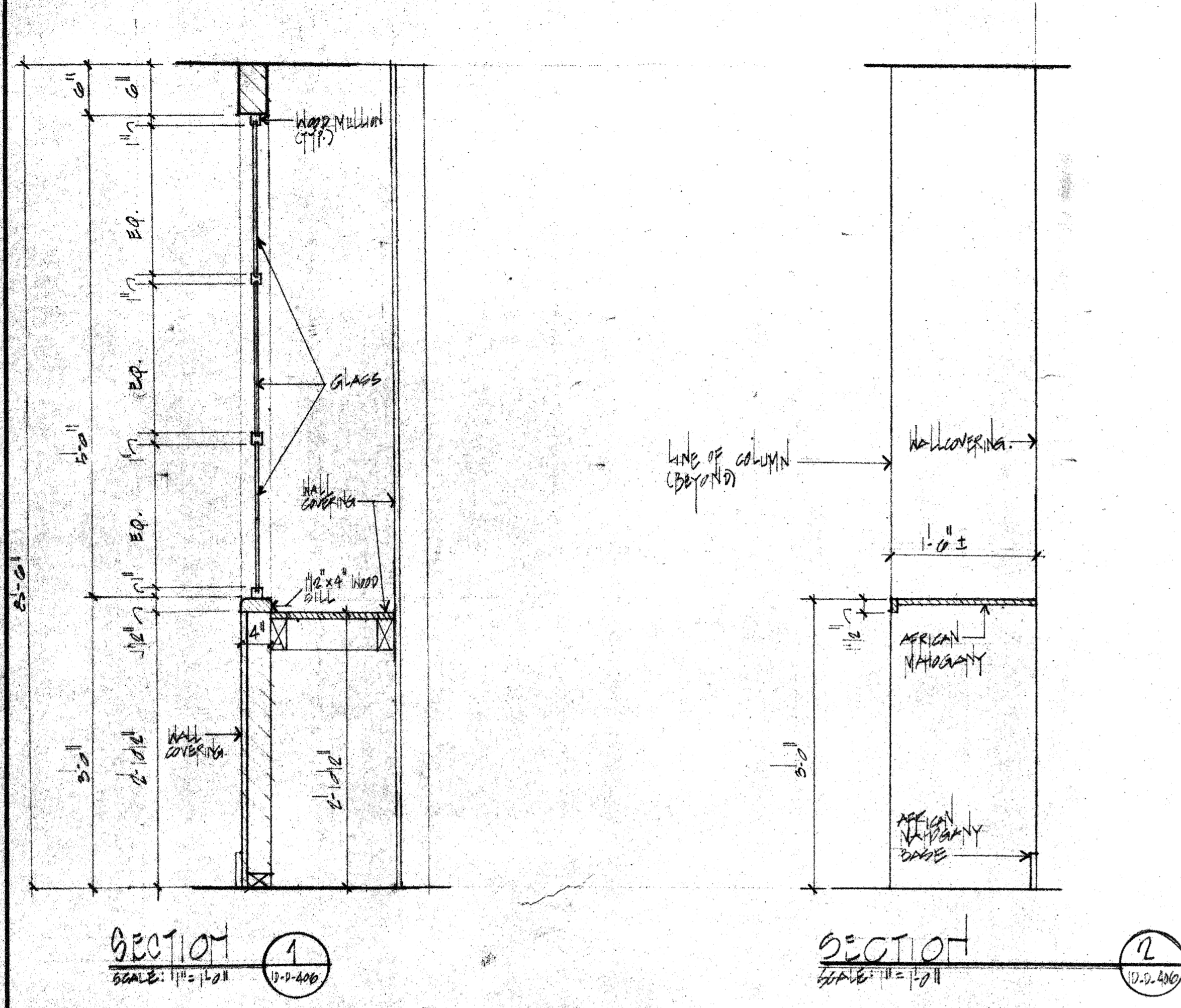

SECTION 1  
SCALE: 1/4" = 1'-0"

SECTION 2  
SCALE: 1/4" = 1'-0"

ID-D-406  
sheet AS SHOWN  
scale AS SHOWN  
date 6-2-53

project  
CAPITAL LAZA HOTEL  
FIRST FLOOR RESTAURANT  
RESTAURANT DETAILS

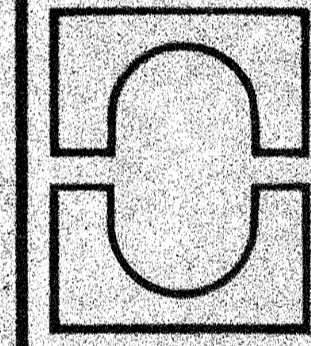

MORRIS-POWELL ASSOCIATES, INC.  
interior designers consultants  
4500 biscayne boulevard — suite 200  
miami, florida 33137  
(305) 576-6551

project no.  
revisions  
05-17-53



SECTION 1  
SCALE: 1/2" = 1'-0"

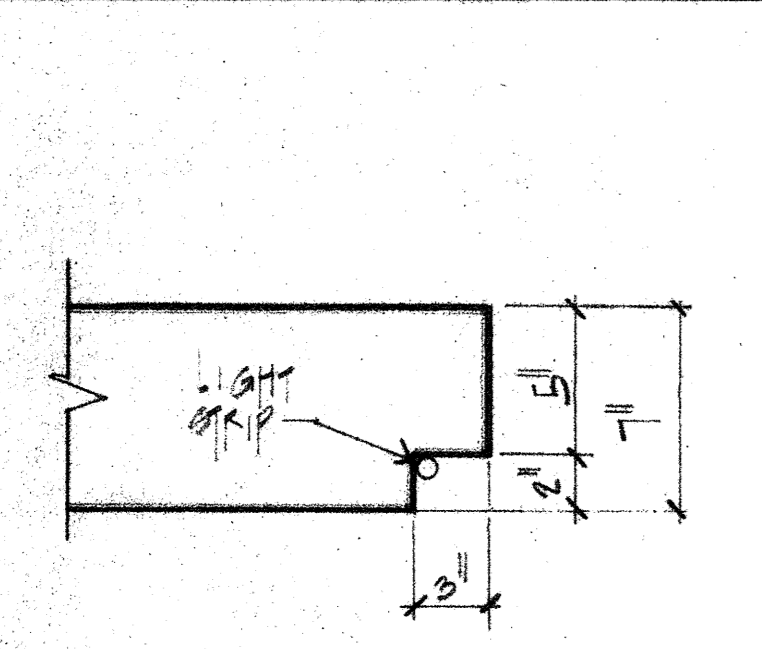

SECTION 2  
SCALE: 1/2" = 1'-0"

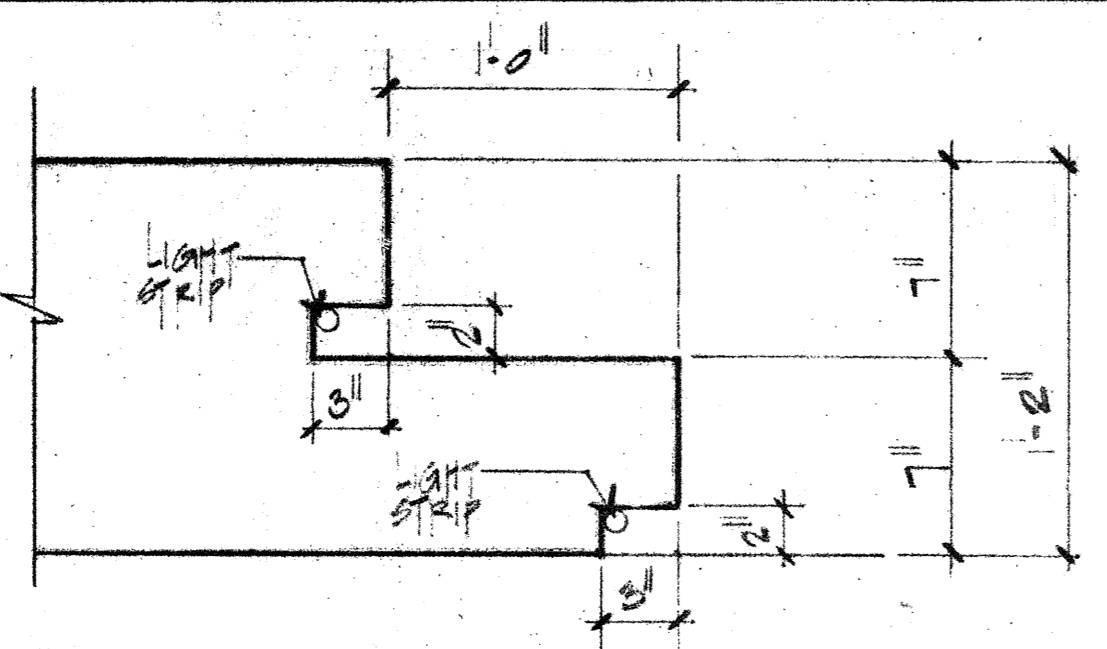

SECTION 3  
SCALE: 1/2" = 1'-0"

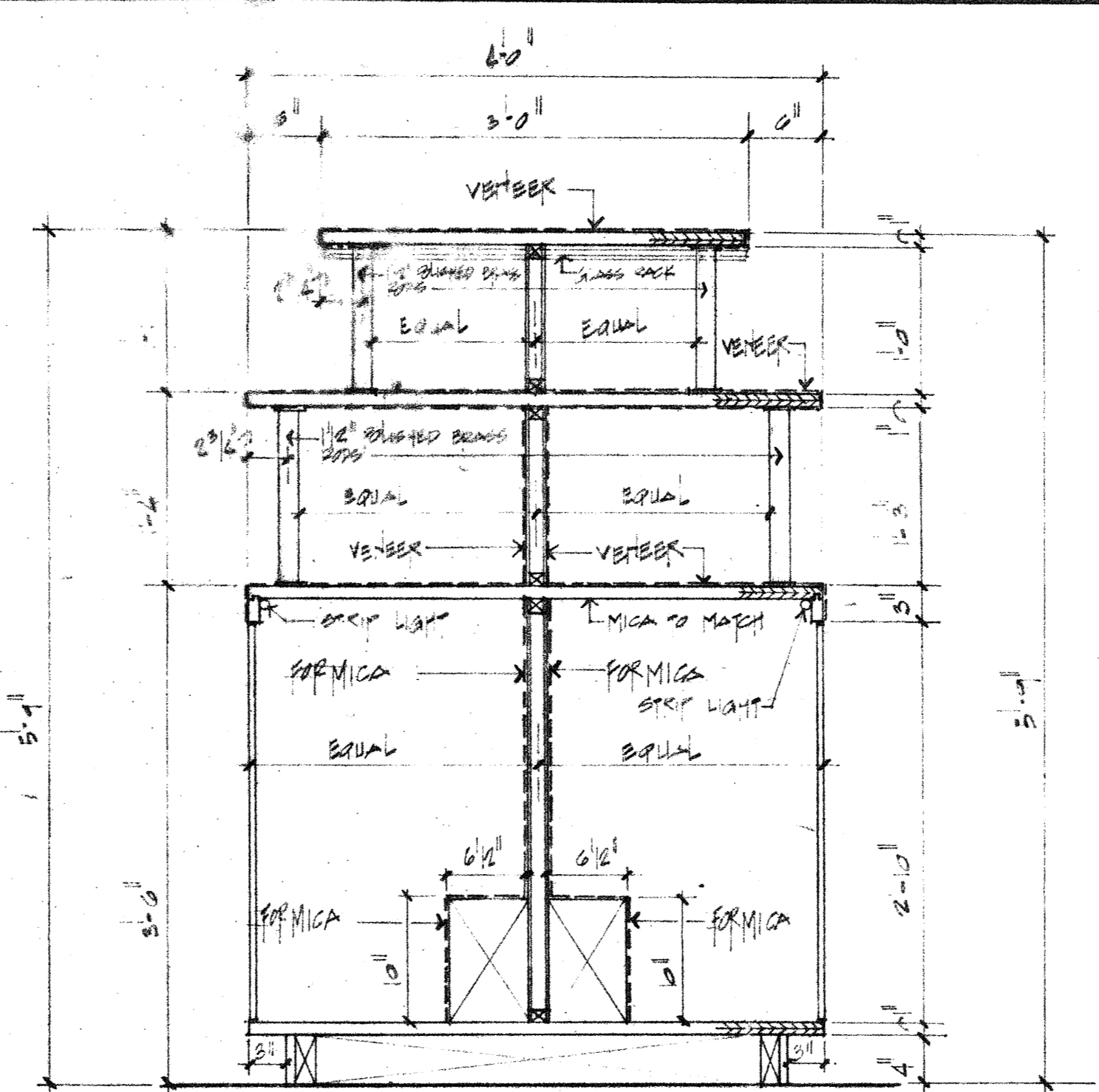

PLAT-DACK BAR  
SCALE: 1/2" = 1'-0"

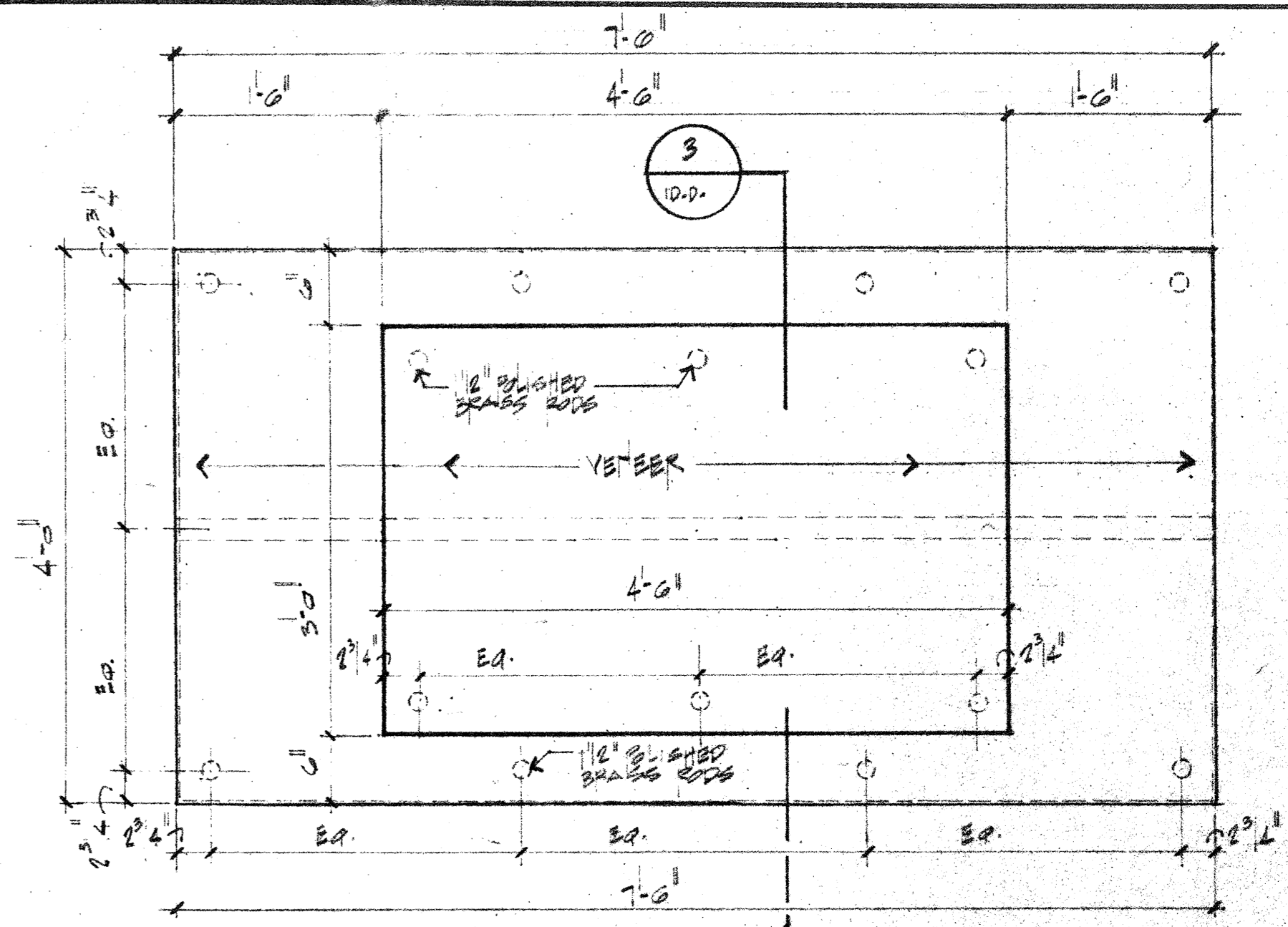

DETAIL C  
FULL SCALE

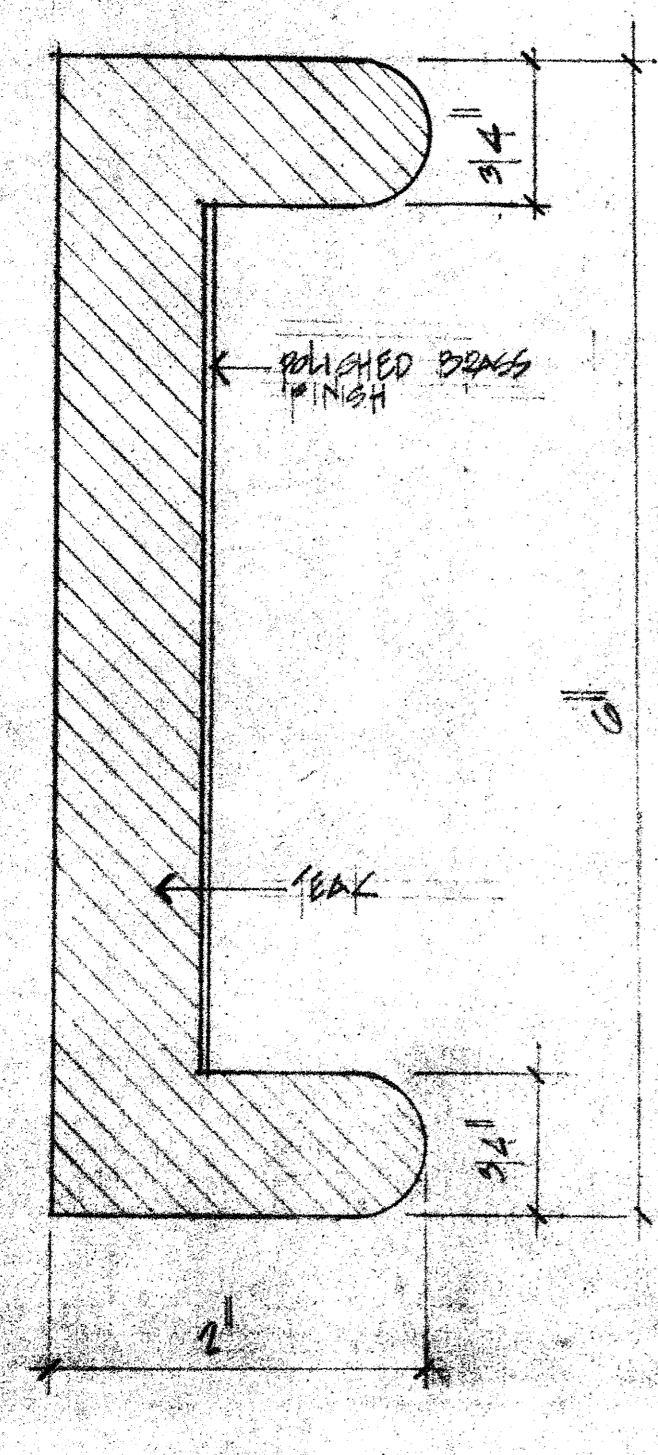

DETAIL E  
SCALE: 1" = 1'-0"

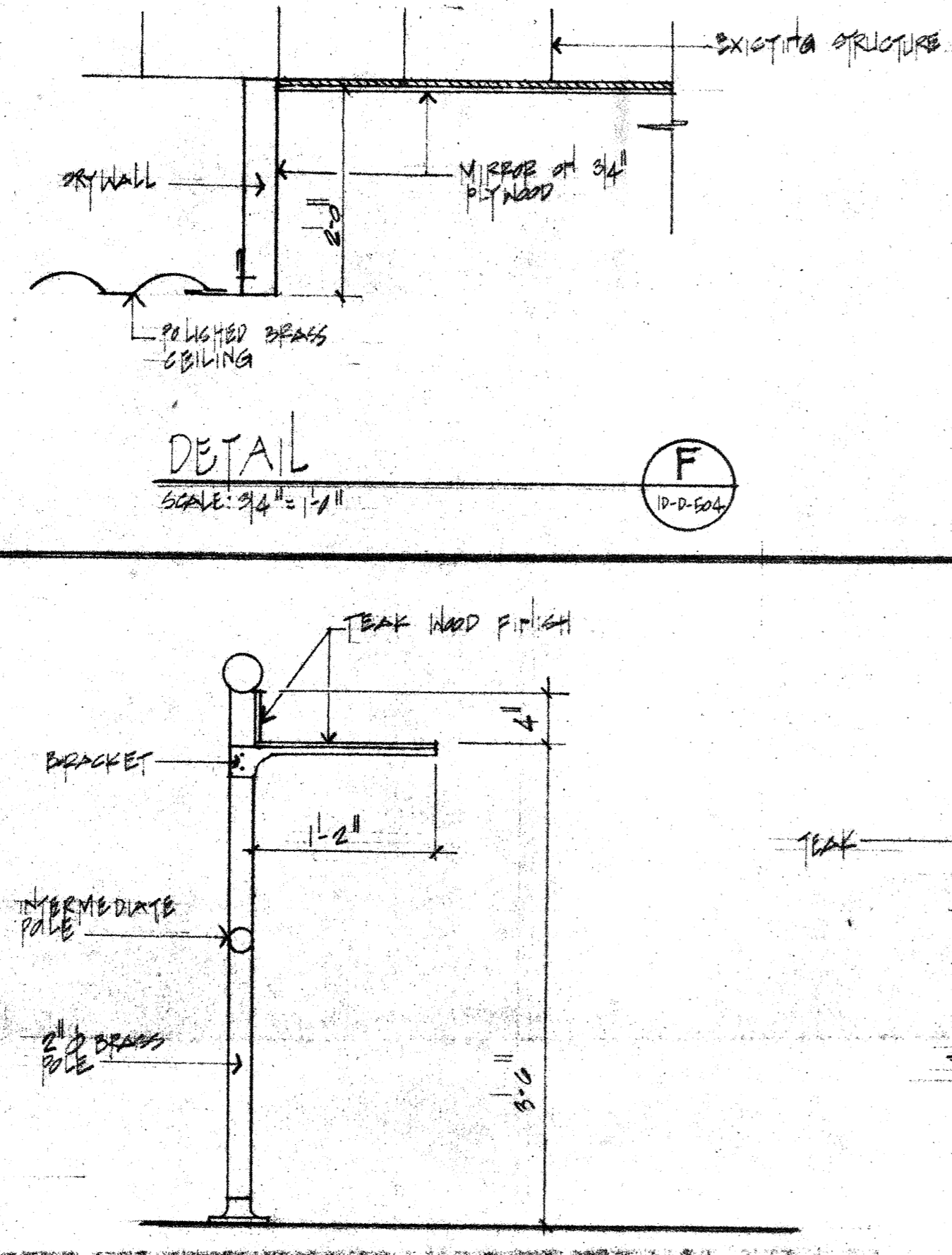

DETAIL G  
FULL SCALE

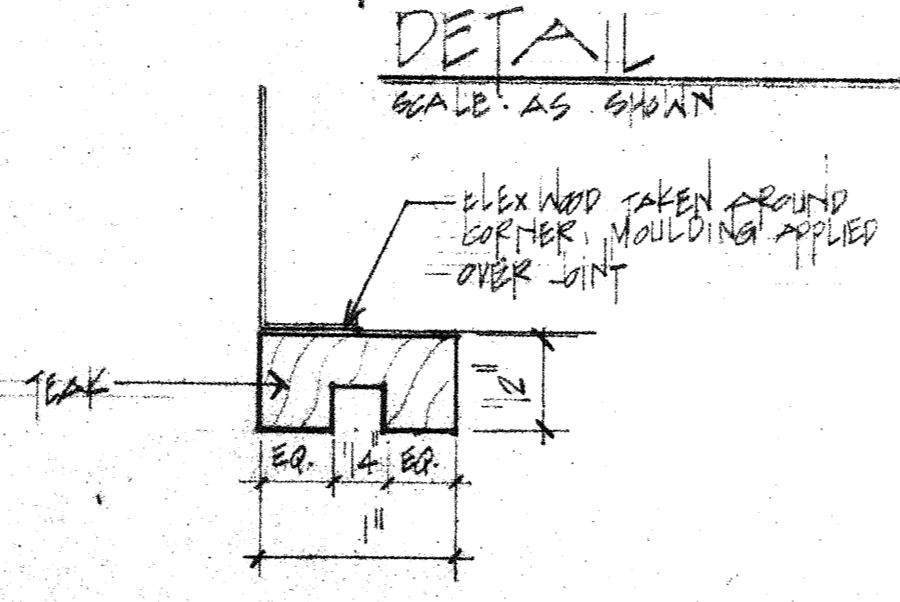

WALL SCOTCH DETAIL H  
SCALE: 3/8" = 1'-0"

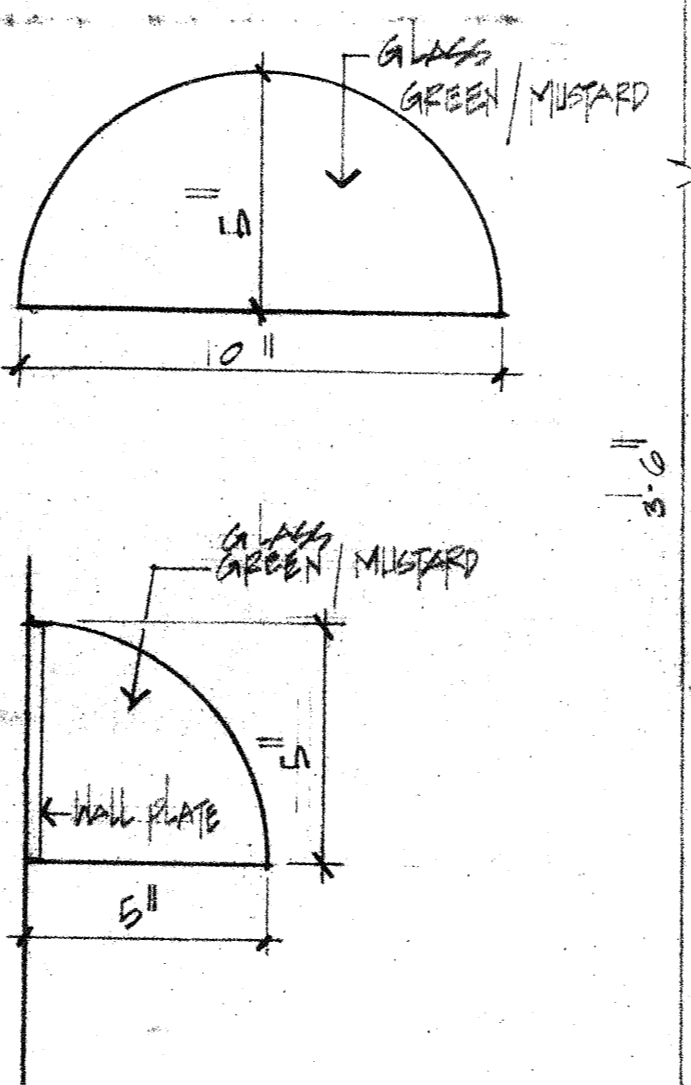

BAR DETAIL B  
FULL SCALE

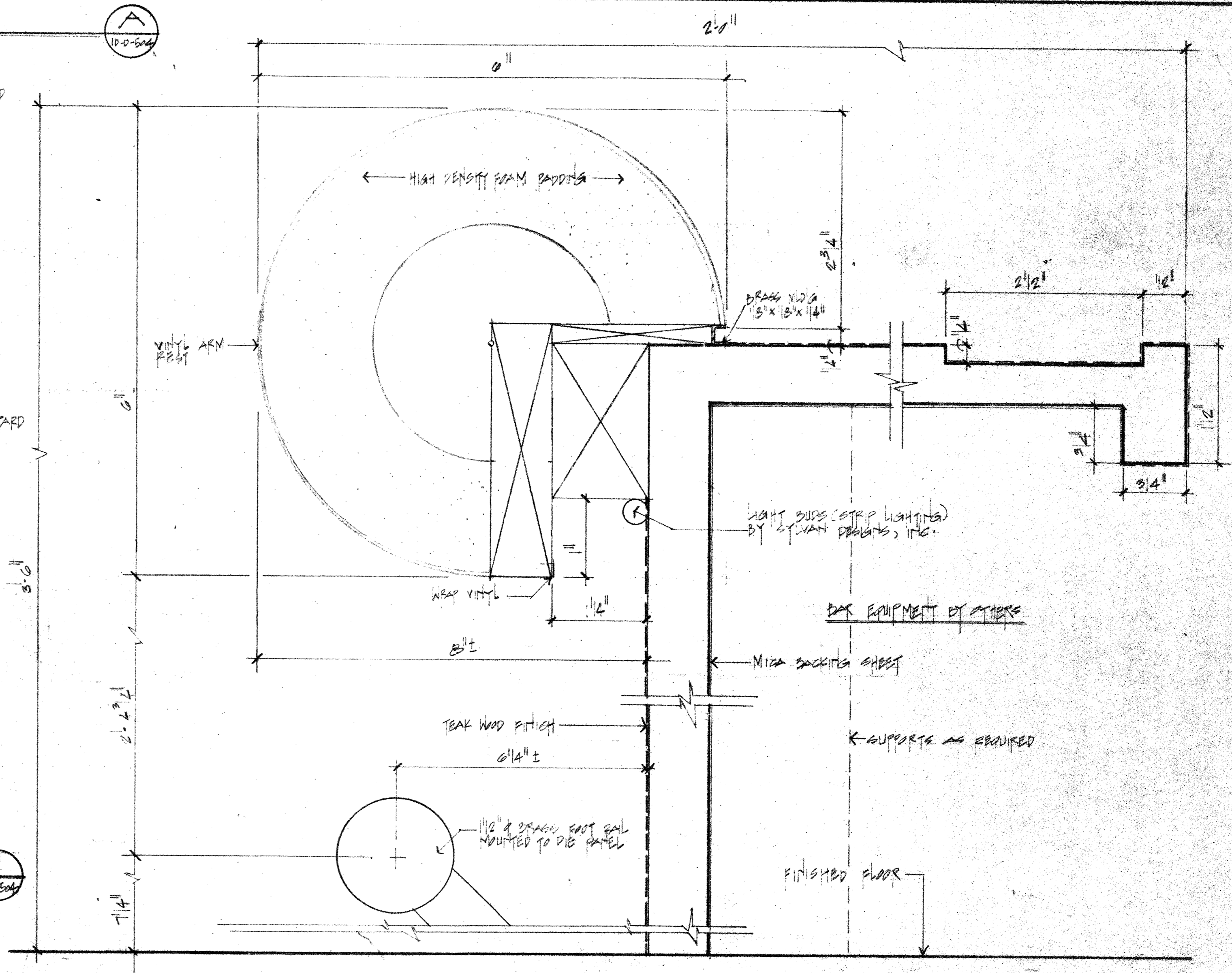

DETAIL D  
SCALE: AS SHOWN

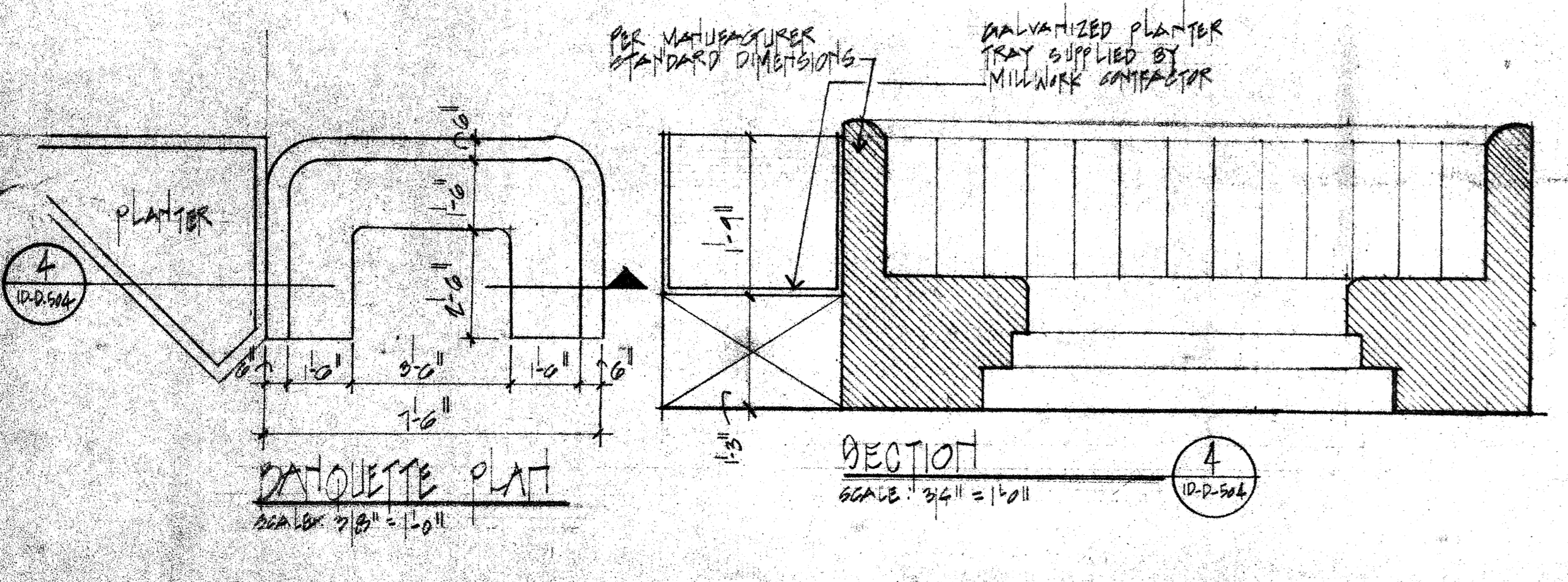

SECTION 4  
SCALE: 3/8" = 1'-0"



DATOUETTE PLAT  
SCALE: 3/8" = 1'-0"

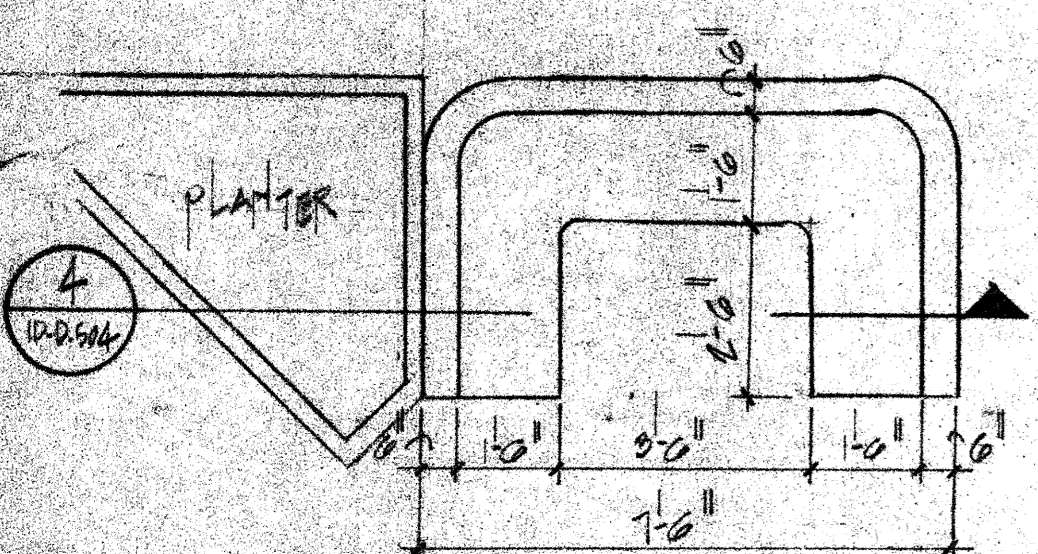

project no.  
revisions  
(1) 7-7-83  
(2) 8-12-83

MORRIS-POWELL ASSOCIATES, INC.  
interior designers consultants  
4500 biscayne boulevard - suite 200  
miami, florida 33137  
(305) 576-6551

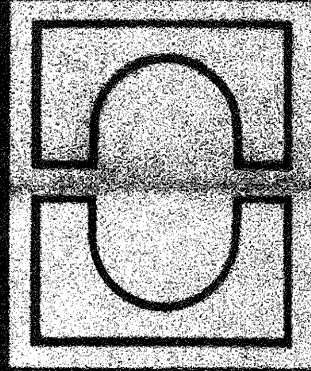

project  
CAPTEL PLAZA HOTEL  
KATKENT KENTUCKY  
BAR-DECK

D-D-504  
sheet  
scale: AS SHOWN  
date: 6-6-83

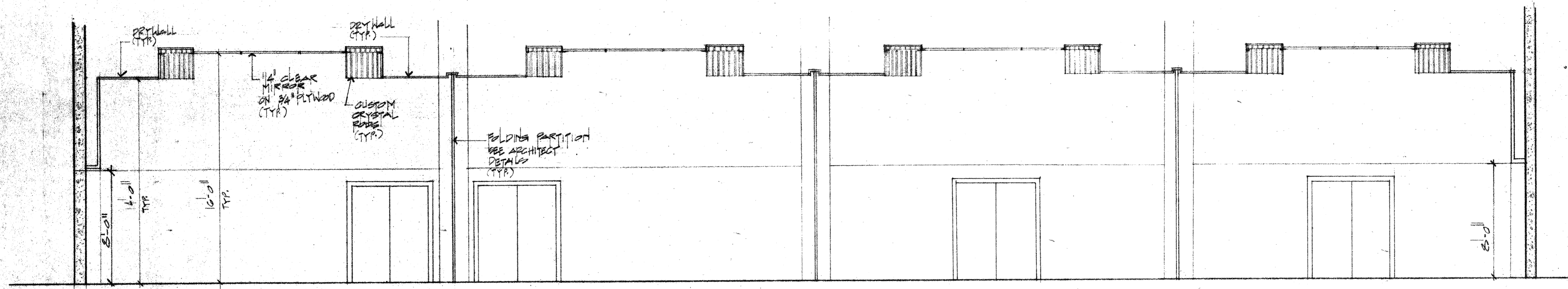

SECTION  
SCALE: 1/4" = 1'-0"

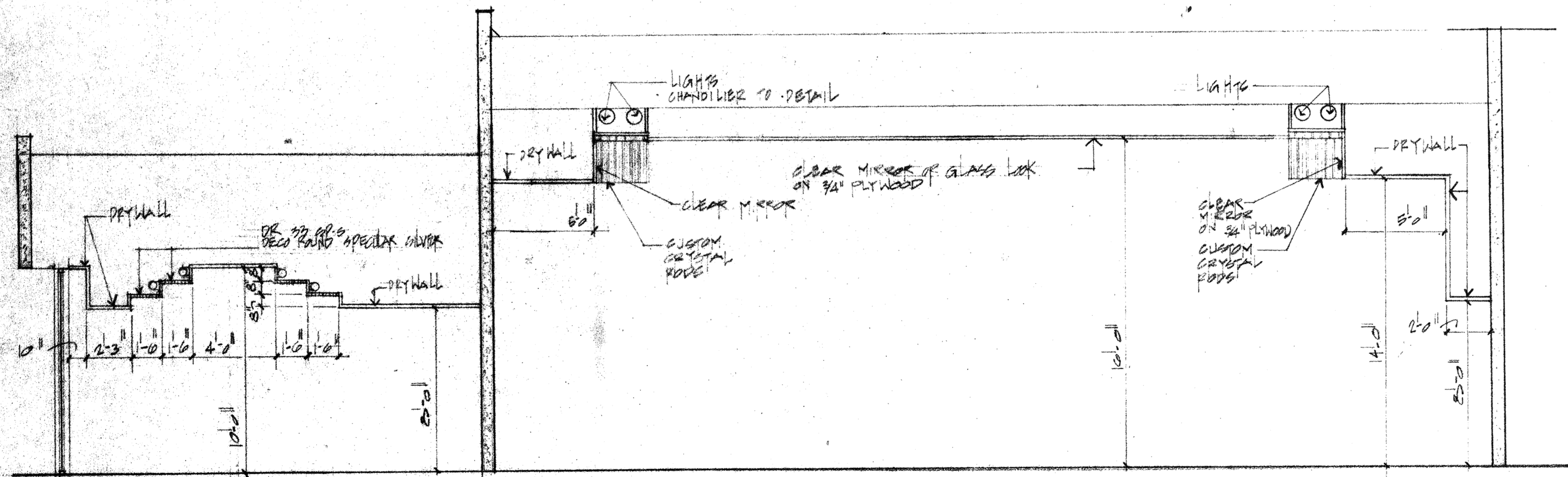

SECTION  
SCALE: 1/4"

project no. revisions (1)-2-12-83	<b>MORRIS-POWELL ASSOCIATES, INC.</b> interior designers consultants 4500 biscayne boulevard suite 20 miami, florida 33137 (305) 576-6551		project PLAZA HOTEL BRADFORD KENTUCKY RE-FUNCTION BALLROOM SECTION